



Silbonit
Fibercement

Guidelines for the use of Silbonit panels



**SOCIETÀ
ITALIANA
LASTRE** S.p.A.

August 2021 edition rev.2

Disclaimer: The contents of this document are correct and up to date at the time of writing. SIL reserves the right to modify the content at any time and without prior notice.

SILBONIT

Ventilated facades with fiber-cement flat-panel cladding

Contents

1	The Società Italiana Lastre SpA company	- 5 -
1.1	System certifications and CE markings	- 5 -
2	Silbonit fiber-cement panels	- 5 -
3	Ventilated facades with Silbonit fiber-cement panels	- 6 -
4	Glossary	- 7 -
5	Components of a ventilated facade – specifications and important considerations.....	- 8 -
5.1	Responsibility	- 9 -
5.2	Subframe	- 9 -
5.3	Waterproofing, thermal insulation, and ventilated cavity.....	- 10 -
5.4	Silbonit cladding panels – technical specifications	- 10 -
5.5	Fastenings	- 13 -
5.6	Accessory elements.....	- 14 -
5.6.1	Gaskets to protect the subframe	- 14 -
5.6.2	Grilles, sheets, and flashings	- 15 -
6	Design considerations and points of caution for ventilated facades with Silbonit panels	- 15 -
6.1	Foreword	- 15 -
6.2	Ventilated facade systems with Silbonit flat-panel cladding.....	- 16 -
6.3	Subframe – general information	- 16 -
6.3.1	Brackets – instructions independent of the material.....	- 17 -
6.3.2	Wooden battens/Metal profiles and expansion joints – instructions independent of the material.....	- 19 -
6.3.3	Wooden subframe	- 21 -
6.3.4	Galvanized steel subframe	- 24 -
6.3.5	Aluminum subframe	- 25 -
6.4	Ventilated cavity.....	- 26 -
6.5	Level 2 and Level 3 fastenings	- 28 -
6.5.1	Level 2 fastenings	- 28 -
6.5.2	Level 3 fastenings	- 29 -
6.6	Cladding panels.....	- 33 -
7	Cladding a facade with Silbonit fiber-cement panels	- 34 -
7.1	Singular points – examples of solutions for certain singular points of the facade packages	- 34 -
7.2	Transport, handling, and storage of Silbonit fiber-cement panels.....	- 41 -
7.2.1	Transport and handling of panels.....	- 41 -
7.2.2	Storage of panels	- 42 -
7.2.3	Manual handling of panels	- 42 -
7.3	Preparing panels for assembly – work on site	- 43 -
7.3.1	General information.....	- 43 -

7.3.2	Cutting.....	- 44 -
7.3.3	Holes	- 44 -
7.3.4	Operations to carry out on the panels after each additional machining.....	- 45 -
7.4	Assembling and installing the fiber-cement cladding.....	- 46 -
7.5	Accessory operations and maintenance of ventilated facades made with Silbonit panels	- 46 -

1 The Società Italiana Lastre SpA company

Società Italiana Lastre SpA was founded in 1961. With its wide range of high-quality products, it has quickly become a leading company in the national and European market for corrugated fiber-cement panel production.

The production of flat panels commenced in 1973, initially designed for prefabricated buildings. The product range then expanded over time, leading to the production of materials for internal and external cladding that represent the company's core business today.

Società Italiana Lastre has always worked and manufactured its products while remaining particularly sensitive to environmental protection, and has adopted a series of measures to ensure a healthy and safe workplace.

Over the years, the company has invested considerable resources in Research and Development, improving the quality performance of its products and processing techniques. The entire workforce – from management to the production team – is highly qualified and trained to ensure the company continuously progresses in its development of products and customer services.

1.1 System certifications and CE markings

Silbonit panels are produced at the Società Italiana Lastre SpA plant in Verolanuova (BS). The production site has obtained the following system certifications:

- UNI EN ISO 9001 Quality Management System
- UNI EN ISO 14001 Environmental Management System

The Silbonit flat panels have obtained:

- EPD (Environmental Product Declaration)
- FDES Déclaration environnementale et sanitaire conforme à la norme NF P 01-010 (Environmental and Health Declaration Complying with Regulation NF P 01-010)
- Certification of the production control system for the CE marking of the panels in accordance with UNI EN 12467

For ventilated facade kits with Silbonit fiber-cement flat-panel cladding, as per 090062-00-0404:

- ETA 17-0318 from the IETcc Instituto de Ciencias de la Construcción Eduardo Torroja (Eduardo Torroja Institute of Construction Sciences), Madrid

SIL reserves the right to modify the information contained in this document at any time and without prior notice. For the latest information on the contents and to check the current version, please consult the company website.

2 Silbonit fiber-cement panels

Silbonit produces fiber-cement flat panels for use as external and internal cladding for walls and ceilings. The panels bear CE marking compliant with the UNI EN 12467 harmonized standard.

This manual refers only to the use of Silbonit panels for **vertical facade cladding**.

The panels are made of fiber cement – a cement matrix mixture with mineral adjuvants, with the addition of organic fibers.

During the continuous production cycle, the mixture is compressed twice and then autoclaved. The raw materials and production technologies give the panels mechanical strength, limit water absorption, and ensure dimensional stability. These unique characteristics make the panels suitable for use even in the most severe environmental and climatic conditions.

As well as being offered in their natural colors, Silbonit flat panels can also be supplied in a variety of other tones. The process uses mass coloration, applying a hydrophobic protective surface with clear acrylic resins. On request, the mass-colored panels can also be treated with acrylic resin coatings from the NCS or RAL range. The panel surface can be smooth or textured.

For the latest information on available finishes and treatments, visit our website at <https://www.sil-lastre.com/>.

Silbonit panels for ventilated facade cladding can be purchased in standard sizes or smaller dimensions cut to customer specifications. They are available in thicknesses of 8, 10, and 12 mm.

The edges of the panels are rectified and their surface is smoothed to ensure their geometry as per the UNI EN 12467 harmonized standard. The smoothing direction follows the direction of the fibers, and is visible on some of the available finishes. This has a great impact on the aesthetic appearance of the facade. These aspects should be taken into due consideration by the Project Architect and installers of the ventilated facade.

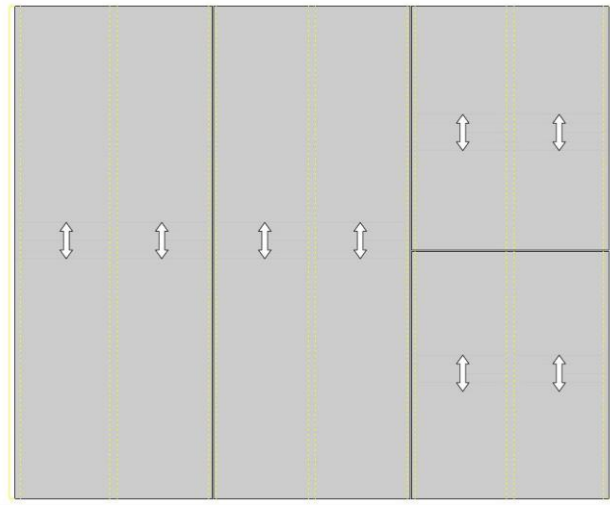

Image 1 – Example of applied cladding panels, with the arrows showing the smoothing direction of the Silbonit panels. The smoothing direction affects the aesthetic appearance of the facade.

During production, the fibers in the panels are oriented parallel to the longest side. This allows for greater strength in the longitudinal direction.

It is important to note that fiber-cement panels, as with any other cladding material, should be viewed taking into account the proper distance that any facade product should be assessed from. Inclusions, nuances, and variations in shade may be observed on the same panel or from one panel to another. The non-uniformity of color and the presence of small markings on the surface of the panels are part of what makes the product unique.

The panels are sold with CE marking and accompanied by the manufacturer's Declaration of Performance (DoP) in accordance with EU Construction Products Regulation 305/2011.

3 Ventilated facades with Silbonit fiber-cement panels

Ventilated facades with Silbonit panels provide a multi-layer system for cladding the external walls of buildings, using components joined by mechanical assembly. They are called ventilated facades because a cavity is created behind the cladding to allow natural and continuous airflow between the supporting wall and the inner surface of the cladding.

This document deals exclusively with Silbonit panels used for vertical external cladding of facades with open joints, with or without layers of insulating material between the panels and the building masonry. In addition, it only considers ventilated facades made by mechanical assembly operations. **Fiber cement is not suitable for outdoor installation using glues or adhesives of any kind.**

Ventilated facades are a non-structural outer shell that serve many functions, such as:

- improving the aesthetics of the building and its architectural value
- renewing the visual impact of buildings and their commercial character
- improving energy efficiency in both summer and winter
- protecting the building from atmospheric agents and pollution, increasing its durability
- improving the acoustic performance
- improving energy performance between the building and the atmosphere, increasing comfort for its users

4 Glossary

Unless otherwise indicated, the terms listed below are used with the meaning given in EAD 090062-00-0404¹ and UNI EN 12467. If necessary, the Project Architect should integrate these definitions with the ones set out in the applicable laws for ventilated facade designs with fiber-cement cladding in force in the location where the ventilated facade will be built and installed.

Term	Definition
Ventilated facade cladding	Components assembled on the walls of a building to form a multi-layer system that provides a wind/rain barrier and also meets additional requirements. The main components are the cladding panels, the ventilated cavity, any insulation, and the supporting structure (or subframe).
Air barrier (air space partition)	An element inserted in the ventilated cavity to vertically or horizontally separate the two spaces within the cavity (from fire or wind pressure). Note: The element must not in any way impede the effectiveness of the ventilated cavity.
Air space	The space between the cladding element and the insulation layer or the load-bearing wall.
Ventilated cavity	A layer of air in contact with the external environment, between the load-bearing wall or insulation layer and the cladding elements. This layer of air allows water, which may enter the space due to condensation or rain, to dry and allows water vapor to diffuse between the inner and outer surfaces of the wall.
Cladding panel	Panels, plates, tiles, half bricks, boards, sheets, or sheets with the edges folded to form a container of durable materials, applied to the outer surface of a surrounding wall such as: wood-based panels, fiber cement , concrete, stone, slate, ceramic, metal, plastic, or HPL laminates. In this document, the definition referred to above by the EAD only applies to Silbonit fiber-cement flat panels.
Cladding fastenings	Profiles, brackets, screws/anchors, nails, rivets, or any special fastenings used to connect a cladding element to the subframe.
Subframe fastenings	Screws/anchors, nails, rivets, or any special fastenings used to connect the components of the subframe together.
Fastening level	By convention, this document defines three levels of fixings for the ventilated facade family with fiber-cement cladding (see EAD – Family A): Level 1 – fastenings that anchor the ventilated facade to the cladded load-bearing wall Level 2 – fastenings that connect the components of the subframe to each other Level 3 – fastenings that connect the cladding elements to the subframe profiles
Ventilated facade kit	A ventilated facade kit is a specific kit for use as external wall cladding and consists of a cladding component, its fastenings, a subframe, an optional thermal insulation product, and other accessory components. In this document, the definition referred to above by the EAD should be interpreted as follows: The facade kits have fiber-cement flat panels as their cladding component. They also consist of a subframe, an optional layer of thermal insulation, and other accessory components,

¹ For brevity, this is hereafter referred to as the EAD

Term	Definition
	designed to improve the general durability of the facade system or some of its parts and to preserve the continuity of the ventilated cavity so that air flow is not impeded over time.
Load-bearing wall	This refers to a wall that already meets the necessary air seal and mechanical strength requirements (resistance to static and dynamic loads), as well as the requirements for water tightness and water vapor resistance. The load-bearing wall can be made of masonry (brick, any type of concrete cast in-situ or prefabricated, or stone), wood, or with metal framing.
Subframe	An intermediate assembly consisting of vertical and/or horizontal profiles, made of wood or metal, and of metal brackets (including fastenings between the brackets and profiles) positioned between the cladding components and the load-bearing wall.
Accessory materials	Semi-permeable membranes, cavity barriers, or any additional components used in the kit (sealants, corner tapes, putties, joint covers, gaskets, compensators, springs, groove protections, strips, waterproofing, etc.). In this document, the definition referred to above by the EAD should be interpreted as follows: Semi-permeable membranes, cavity barriers, or any additional components used in the kit (profiles, flashings, gaskets, etc.) to improve the general durability of the facade system or its parts and to preserve the effectiveness of the ventilated cavity so that the air flow is not impeded over time.
Vapour permeable membrane	A membrane included in the ventilated facade kit that contributes to the water-tightness of the load-bearing wall.
Legislation or mandatory regulations	Binding national or supranational (e.g. European) prescriptive documents applicable in the location where the ventilated facade will be built and installed.
Technical or voluntary standards	National or European provisions issued by the relevant standards organizations, adherence to which is generally voluntary (such as UNI standards, EN standards, etc.) unless expressly set out by law.
Fitting, assembly, installation	All operations carried out on-site to create the ventilated facade according to the Project Architect's specifications.
Installer, assembler, fitter	The person contractually assigned responsibility for installing the ventilated facade.

5 Components of a ventilated facade – specifications and important considerations

Ventilated facades can clad existing or new buildings for civil, commercial, or industrial use. They can be mounted on load-bearing supports made from all common building materials such as concrete (including prefabricated concrete), brick masonry, and constructions with wooden or steel load-bearing frames. They are generally comprised of the following components:

1. Subframe, which is anchored to the building
2. Optional layers of waterproofing and/or thermal insulation
3. Fiber-cement flat-panel cladding which, when assembled, forms the outermost part of the facade and therefore the building enclosure
4. All fastenings and other completion components (such as components to prevent thermal bridges) required to anchor the subframe to the building and to connect the facade components to each other
5. Other accessory and completion components required to ensure the durability and functionality of the facade over time (such as elements for partitioning the ventilated cavity, gaskets to protect the subframe, etc.). These construction details and finishing details depend on the installation conditions, the environment, and the properties of the building that will be clad

5.1 Responsibility

Without prejudice to the responsibilities established by the laws in force and by the technical standards (national and supranational) applicable in the location where the ventilated facade is to be installed, the Project Architect is responsible for the facade design, the requirements of all the components it is made of, its installation, and maintenance. These requirements must be defined by taking into account the specifications and condition of the load-bearing structure that the facade will be mounted on, along with the environmental and climatic properties of the site (operating temperatures, aggressiveness of the environment, etc.).

As far as applicable, the Project Architect is responsible for all matters concerning the choice, sizing, calculation, installation, and maintenance requirements of:

- the cladding panels
- the subframe components
- the fastening elements required to create the facade and to anchor it to the supporting structure
- components designed to ensure the durability and functionality of the ventilated facade over time (e.g. insulation layer, elements to be used to protect the joints, etc.)

When designing the ventilated facade, the Project Architect must also consider the stresses which it may be subjected to during the intermediate stages of construction, such as the possible effects caused by wind. Based on those assumptions, the Project Architect must prescribe everything needed to ensure proper and safe execution, including in the intermediate assembly stages, up until the final project configuration/installation has been completed.

The Project Architect is also responsible for the document establishing the requirements for maintenance of the ventilated facade, if such a document is required legally or contractually under the terms established with the facade client.

Without prejudice to the responsibilities established by the laws in force and by the technical standards (national and supranational) applicable in the location where the ventilated facade is to be installed, it is the installer's responsibility to check the specification and condition of the load-bearing structure which the ventilated facade will be fitted onto, to note any differences in respect of the design assumptions and requirements, and to communicate this to the Project Architect so that they may take note and modify the design.

The installer is responsible for the assembly and installation of the facade, including its anchoring to the building, in accordance with the Project Architect's instructions.

SIL provides guidance derived from operational practices, but this cannot and must not be interpreted in any way as a substitute for design planning and the pertinent legal requirements.

5.2 Subframe

The subframe of a ventilated facade with Silbonit fiber-cement flat-panel cladding is a multi-layer system broadly composed of:

- Metal brackets
- Vertical wooden battens or metal profiles which are fixed to the brackets
- Fastenings connecting the brackets and battens/profiles

Its purpose is to support the cladding and transfer all the distributed and concentrated stresses to the building that the facade withstands during its installation and working life. These stresses may be mechanical, from pressure and depression stresses due to wind, or they may result from occasional impacts in public areas. They may also be thermo-hygrometric, for example due to heat expansion and changes in atmospheric humidity.

There are two main types of brackets – brackets designed to support predominantly vertical loads (e.g. the cladding's own weight) also known as "load-bearing brackets", and brackets designed to support predominantly horizontal loads (e.g. the stresses transmitted by the cladding) also known as "retaining brackets".

The brackets are anchored to the building with fastenings, or anchors. Their sizing is the responsibility of the Project Architect and is not addressed in this document.

Silbonit panels are only suitable for vertical cladding. The flatness and verticality of the subframe must be prescribed by the Project Architect and verified before the cladding is fitted.

The sizing of all the components of the subframe must be calculated and verified. Their arrangement on the facade and the reciprocal distances between the different elements must also be considered within the sizing procedure, in order to ensure the strength of the cladding system and obtain the desired aesthetic result.

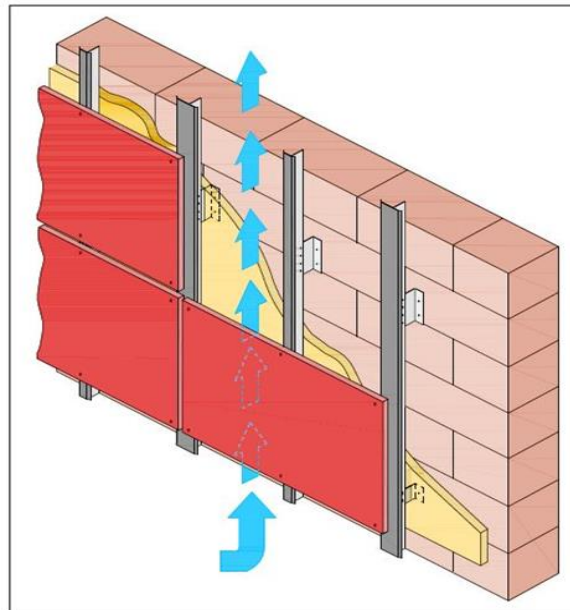

Image 2– Example of subframe with metal profiles and brackets. This laying configuration includes a layer of thermal insulation (optional). The arrows show the flow of air circulating in the ventilated cavity.

5.3 Waterproofing, thermal insulation, and ventilated cavity

Layers of materials with different purposes (insulating and/or for water-tightness) can optionally be fitted on the outer surface of the load-bearing wall to improve the performance of the building.

If used, these materials must be sized according to the desired characteristics or contractual requirements that the cladded building must meet. The insulating and waterproofing layers must be fitted on the external surface of the building, fixed according to their manufacturer’s instructions, if any, or according to the specifications dictated by the Project Architect in order to avoid negative interference with the subframe elements and the free flow of air in the cavity. Particular care must be taken in their selection and the way they are installed, in order to prevent any deformation over their working life that could reduce the ventilation chamber.

Using these materials can affect the total thickness of the subframe, and this should be taken into due consideration.

If necessary, the cavity can be partitioned with suitable horizontal and/or vertical barriers in order to separate the air space contained inside it, and thereby confine any potential spread of a fire or the effects of wind. When doing so, care must be taken not to hinder air circulation.

5.4 Silbonit cladding panels – technical specifications

The following tables outline the standard geometrical specifications of Silbonit fiber-cement flat panels. These specifications comply with the requirements of the UNI EN 12467 standard.

Standard dimensions		
Length (mm)	Width (mm)	Thickness (mm)
2500	1200	8, 10, 12
2500	1250	8, 10, 12
3000	1200	8, 10, 12
3000	1250	8, 10, 12
3050	1200	8, 10, 12
3050	1250	8, 10, 12

Table 1 – Dimensions of the panels in standard format

Tolerances for standard dimensions Level 1 (as per UNI EN 12467)	
Length	± 2 mm
Width	± 1 mm
Thickness	± 0.2 mm
Edge straightness	0.1%
Perpendicularity of edges	2 mm/m

Table 2 – Tolerance guaranteed by manufacturer. The geometric tolerances are Level 1 as per UNI EN 12467.

Thickness	Weight (kg/m²)
8	14.4
10	18
12	21.6

Table 3 – Unit weight of panels depending on their thickness

The following table shows the physical and mechanical specifications of Silbonit panels.

	Unit of measurement	Value
NOMINAL DIMENSIONS AND GEOMETRY		
Length	mm	2500 3000 3050
Width	mm	1200 1250
Thickness	mm	8, 10, 12
Dimension tolerances	Classification as per UNI EN 12467:2016	Level 1
Length	mm	± 2
Width	mm	± 1
Edge straightness	%	0.1
Perpendicularity of edges	mm/m	2
Tolerances for the thickness of smoothed panels	mm	± 0.2
Nominal weight	kg/m ²	14.4 (t=8mm) 18.0 (t=10mm) 21.6 (t=12mm)
PHYSICAL PROPERTIES		
Specific weight in dry state	kg/m ³	1600 ± 50
MECHANICAL PROPERTIES		
Modulus of elasticity E (ambient condition)		
- Longitudinal	GPa	14
- Transversal	GPa	12
Modulus of elasticity E (conditioned in water)		
- Longitudinal	GPa	11
- Transversal	GPa	9
Flexural breakage resistance (immersed in water for 24 hours)	MPa	≥ 24
Compressive strength	MPa	40

	Unit of measurement	Value
Impact resistance (Charpy test)	As per EN 179-1:2010	
- Longitudinal	kJ/m ²	4.3
- Transversal	kJ/m ²	3.1
HYGROMETRIC PROPERTIES		
Humidity in its natural state	%	10 ÷ 15
Maximum water absorption* (Hydro, HydroPlus, Spectra)	%	9 ± 3
Maximum water absorption* (Crystal, Pigmenta)	%	3 ± 2
Humidity Behavior – Shifts from 30% to 90% humidity		
- Longitudinal	mm/m	0.7
- Transversal	mm/m	0.8
THERMAL PROPERTIES AND WATER VAPOR TRANSMISSION (UNTREATED PANEL)		
Permeability to vapor, μ – as per EN 12572:2016	---	49
Thermal conductivity – as per EN 12664:2002	W/mK	0.42
Coefficient of linear thermal expansion – as per EN 10545-8:2014		
- Longitudinal	1/°C	1.71•10 ⁻⁶
- Transversal	1/°C	0.58•10 ⁻⁶
OTHER PROPERTIES		
Higher calorific value (mass-colored panel)	MJ/kg	1.2 (12 mm) 1.3 (5 mm)
Higher calorific value (non-mass-colored panel)	MJ/kg	1.0
Reaction to fire	As per EN 13501-1	A2 s1 d0
Freeze-thaw resistance		RL ≥ 0.75
Durability class	As per UNI EN 12467:2016	Category A
Strength class (immersed in water 24 hours)	As per UNI EN 12467:2016	Class 5
Resistance oils, acids, bases, salts		Good
Water impermeability	As per UNI EN 12467:2016	Compliant
Wear resistance		Good
Resistance to wet scrubbing and cleanability (for Crystal and Pigmenta finishes)	As per UNI EN ISO11998:2006 UNI EN 13300:2002	Class 1
CE marked product	---	UNI EN 12467:2016

* dries in 24 hours in an oven at 100 °C and immersed in water for 24 hours

Unless otherwise specified, the tests are as per UNI EN 12467.

Table 4 – Physical and mechanical specifications of Silbonit panels

For the latest technical data please refer to the download area at <https://www.sil-lastre.com/download-2/>

The classification as per the UNI EN 12467 standard of autoclaved and double-compressed Silbonit fiber-cement flat panels is as follows:

Panels	Property	Classification as per UNI EN 12467	Notes
All	Production technology	NT	"Non-asbestos" or even "Asbestos-free" technology
All	Weather resistance	Category A	For outdoor applications in severe climatic conditions (can withstand heat, high humidity levels, intense frosts)
Surface-treated panels	Strength	Class 5	Modulus of Rupture (MOR) ≥ 24 MPa
All	Geometric tolerances	Level 1	See the technical specifications table of the panels
All	Reaction to fire	A2S1d0	A2 = non-flammable S1 = a little smoke emitted d0 = no flaming droplets produced

Table 5 – Classification as per UNI EN 12467 standard

5.5 Fastenings

The fastenings referred to in this paragraph for facades with fiber-cement cladding are point and visible type fastenings. Hidden point fastenings that can be used with this type of facade are not addressed.

The following image shows the typical components of a ventilated facade comprised of Silbonit panels and indicates the three levels of fixing:

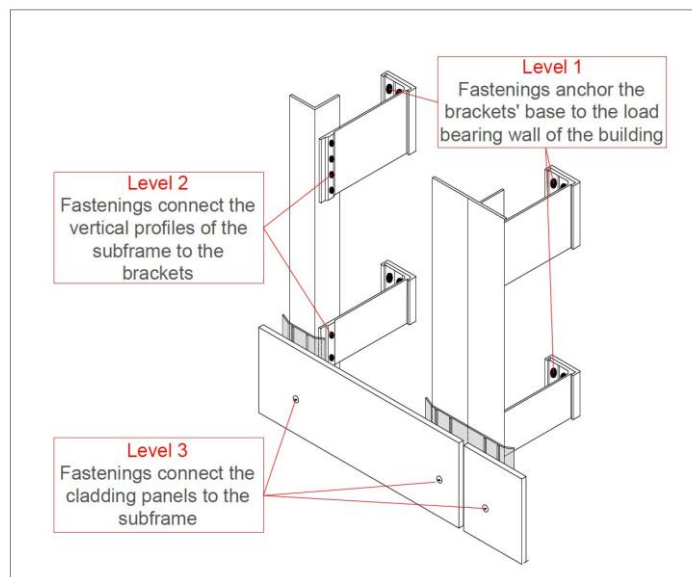

Image 3– The diagram shows the 3 fixing levels used as a convention in this document

Level 1 fastenings anchor the subframe to the load-bearing wall of the building, Level 2 fastenings connect the vertical battens/profiles of the subframe to the brackets, and Level 3 fastenings connect the cladding panels to the subframe.

Level 1 fastenings and their sizing are not covered in this document. The type and dimensions of these fastenings also depend on the specifications of the load-bearing support and must therefore be chosen and sized by the Project Architect of the ventilated facade.

Level 2 and Level 3 fastenings can be screws and rivets. The type, size, and material must be selected by the Project Architect taking into account not only their strength but also their compatibility with the materials of the other ventilated facade components.

The fixing points of the panels (Level 3 fastenings) can be two different types: “fixed” or “sliding”. The fixed ones are designed to withstand vertical loads, such as the panels’ own weight, while the sliding ones are designed to withstand horizontal loads and allow the panels to adapt to changing thermo-hygrometric conditions.

The diameter of the holes must be taken into careful consideration for both fixed and sliding fastenings, in order to prevent errors during installation.

The material of the fastenings is conditioned by what is chosen for the other components of the subframe. The following table outlines some of the possible combinations of materials. The Project Architect must verify this with the component suppliers.

Level 1 fastenings	Subframe element	Level 2 fastenings	Subframe element	Level 3 fastenings	Cladding element
Not covered in this document	Adjustable galvanized steel brackets	Stainless steel screws	Wooden battens	Stainless steel screws	Fiber-cement panels
	Adjustable galvanized steel brackets	Stainless steel screws	Galvanized steel profile	Stainless steel screws	
	Adjustable galvanized steel brackets	Stainless steel rivets	Galvanized steel profile	Stainless steel rivets	
	Adjustable aluminum brackets	Stainless steel screws	Aluminum profile	Aluminum/Stainless steel rivets	

Table 6 – Left to right, the elements of a ventilated facade with Silbonit panels

Silbonit panels can be laid with the longitudinal axis positioned vertically or horizontally. The strength of the panels, however, depends on the direction of the fibers. The Project Architect must therefore take this into consideration when sizing the fastenings and when sizing the distances between the Level 2 and Level 3 fastenings, to ensure that the facade can withstand all anticipated stresses, such as mechanical, chemical, hygrothermal, etc.

5.6 Accessory elements

To complete the ventilated facade system, other components are also required in addition to the main components indicated above. We refer to these additional components as “accessory elements”. Their purpose is to improve the overall durability of the facade system or some of its parts, and to maintain the effectiveness of the ventilated cavity to ensure that the air flow through it is not impeded over time.

5.6.1 Gaskets to protect the subframe

A gasket of suitable thickness and width must be installed on all the battens/profiles of the subframe to protect them from rain and condensation and to facilitate proper water runoff.

The thickness of the gaskets must be considered when sizing the length of the fastenings.

EPDM gaskets or polyethylene foam gaskets are two example types of gasket that can be used.

As well as serving as protection, the design of the section of these gaskets facilitates proper water runoff and helps to prevent the formation of stagnant water that could damage the cladding. Additionally, they can contribute to a better aesthetic result for the facade by hiding the surface of the subframes (metal subframes in particular are usually gray or metallic and would be visible along the joints of the cladding, especially if dark colored panels are used).

The section of these gaskets aids rainwater runoff and helps to protect the edge of the panels beneath the staggered joints.



Image 4– Protective gaskets for the subframe profiles. Standard sections widely available

Profiles used to seal the horizontal joints between the joints used to hide the subframe are widely available. In all cases, they must enable the panels to move in response to thermo-hygrometric stress, ensure correct and effective water runoff, and guarantee proper ventilation at all times. However, it is best if the facade can be left with open joints, without sealing profiles.

5.6.2 Grilles, sheets, and flashings

To complete the facade and protect the ventilated cavity, ventilation grilles and/or protective grilles should be used to protect against insects and rodents, as well as coping flashings on the roof and sealing sheets along the windows or entrances.

These components, made with metal or plastic profiles, are widely available.

The Project Architect is responsible for assessing their use and installation in accordance with the installation and working life requirements of the facade system as a whole. They will need to adequately protect the panels, while ensuring air flow. Where perforated grilles are required, the size of the holes must allow sufficient air passage.

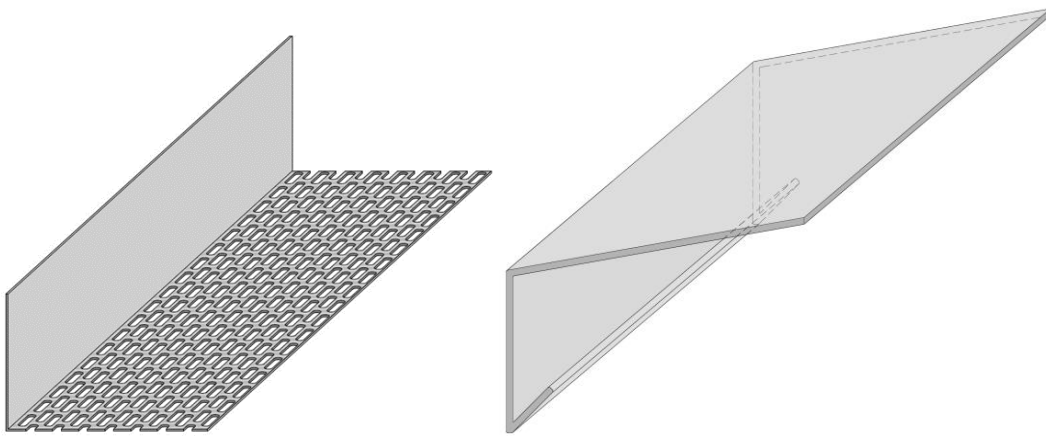

Image 5– Example of standard sections available for metal grilles and flashings used to protect the ventilated cavity.

6 Design considerations and points of caution for ventilated facades with Silbonit panels

6.1 Foreword

The contents of this section and the suggestions offered to Project Architects are based on current practice and EAD 090062-00-0404, rev. July 2018, “Kits for external wall claddings mechanically fixed”, also referred to as the EAD throughout the rest of this guide. The EAD is a guide from the EOTA (European Organisation for Technical Assessment), developed and issued to support manufacturers who want to voluntarily obtain an ETA to apply CE marking to ventilated facade kits. Among other activities, the EAD performs assessments on mechanically fixed kits for external wall cladding.

At the time of this document’s publication, there are no binding or voluntary Italian national regulations specific to ventilated facades with fiber-cement cladding. A harmonized standard is also not currently available, meaning it is not possible to obtain CE marking for these systems unless the manufacturer voluntarily requests an ETA (European Technical Approval) to be issued by the EOTA.

In an attempt to fill this regulatory gap and provide its customers with an objective way to evaluate Silbonit panels, as well as useful information for Project Architects, SIL has **voluntarily** decided to qualify certain vertical cladding facade kits with Silbonit fiber-cement flat panels and has obtained an ETA for the “External wall cladding kit” as per the EAD.

The information contained in this document may never be used as an alternative to that required by the laws applicable in the place where the facade is to be installed.

6.2 Ventilated facade systems with Silbonit flat-panel cladding

Ventilated facades are, in general, non-structural systems for externally cladding buildings. The term “non-structural” means – as per the Construction Products Regulation – that they do not contribute to the fulfillment of Basic Requirement 1 of “Mechanical strength and stability” for construction works. Nevertheless, they must withstand the loads and stresses which they are subjected to during their working life and during installation.

The EAD indicates the Basic Requirements that apply to this type of system and the Essential Characteristics of the components of a ventilated facade allowing them to meet those requirements.

A ventilated facade kit made with Silbonit flat-panel cladding falls within Family A, i.e. systems where the cladding components are mechanically connected to the subframe using visible fastening points. This type of system is subject to the Basic Requirements set out in Table 2.1 of the EAD.

In order to obtain ETA 17-0318 “Kit for external wall cladding”, SIL has prepared some kits that have been submitted to the laboratories of the TAB (Technical Assessment Body) and undergone the tests prescribed by EAD. The specifications of the kits, the test results, and the conditions under which they were obtained are made available by SIL, on request, together with the ETA. **This information can support, but is not a substitute for, the Project Architect’s work and evaluations when designing the facade.**

To better understand and appreciate the contents of the ETA, please refer to EAD 090062-00-0404, which includes:

- The description of Family A based on the type of cladding and its fastenings (Table 1.1)
- The relationship between the “Essential Characteristics” and the “Basic Requirements for construction works” applicable to kits of Family A (Table 2.1)
- Test methods and performance assessment criteria for each essential characteristic applicable to the kits (Table 2.1)
- A summary of the assessment methods of the “Mechanical strength” essential characteristic for the components of Family A kits, referring to Basic Requirement 4 for construction works, “Safety and accessibility during use” (Table 2.2)

The Project Architect can then examine in detail how to test and evaluate the performance of each essential characteristic directly within the EAD.

Please note that reference to EAD requirements by manufacturers is voluntary and that the test results contained in ETA 17-0318 apply only to the kits described therein.

In the following sections, the general indications for sizing the components for a ventilated facade are accompanied by examples taken from the kits which have obtained ETA 17-0318.

Finally, we reiterate that Silbonit fiber-cement panels must only be used as vertical facade cladding and that all the considerations and instructions provided in this document refer exclusively to that use.

6.3 Subframe – general information

The subframe of a ventilated facade with Silbonit fiber-cement flat-panel vertical cladding generally comprises of:

- Metal brackets
- Vertical wooden battens or metal profiles which are fixed to the brackets
- Fastenings between the brackets and battens/profiles

The group of battens/profiles form the vertical support surface for the ventilated facade cladding. They can be made from the following materials:

- Wood
- Galvanized steel
- Aluminum

The verticality and flatness of the external surface created by the profiles (and designed to form the supporting surface of the cladding panels) must be guaranteed during installation. Verticality and flatness assessments must be performed and, if necessary, prescribed by the Project Architect.

The Project Architect must size the vertical battens/profiles of the subframe and the brackets with consideration for the legal requirements and, more generally:

- the stresses arising from the load on the cladding and the external forces which the ventilated facade will be subjected to during its working life and assembly
- the materials, specifications, and conservation status of the walls which it will be anchored to
- the environmental properties where the facade will be built and located, as its durability may be affected (e.g. temperature and humidity, degree of aggressiveness of the environment, and any durability requirements that the facade may have)

The facade system must be designed, built, and maintained in such a way that the stresses it is subjected to when installed and throughout its useful life can be discharged onto the structure of the building it is anchored to.

For example, aspects such as the distance between the elements of the subframe and their sizes, as well as the sizing of the anchors on the load-bearing wall, must be addressed and designed in such a way so that the subframe is able to support its own weight, the weight of the cladding panels, and the force transmitted to the ventilated facade by wind and other atmospheric agents. In addition, the subframe must be able to transfer these stresses to the load-bearing wall.

Furthermore, the subframe must absorb the stresses arising from the settling of the elements of the ventilated facade of the cladding, which are induced by hygrothermal variations. Particular care must be taken in the choice of subframe components and anchorage methods to the load-bearing wall where a suitable thermal bridge management is required, if defined.

The geometrical and material specifications, as well as the dimensions of the components of the subframe and of the ventilated facade described in the following paragraphs, should be considered as general indications, and therefore minimum or maximum values that the Project Architect must verify. Where necessary, the values given here must be amended in line with the specific calculations in question, so as to ensure that each component and the facade as a whole can withstand the stresses, both during construction and throughout its working life.

Vertical ventilated facades, clad with Silbonit fiber-cement flat panels, may also be designed and manufactured with subframes, fastenings, and accessory materials other than the ones indicated here, provided that they have – as appropriate and applicable – chemical, physical, mechanical, and functional specifications that guarantee they are suitable for use and compliant with the laws and technical standards applicable in the location where the facades will be installed.

The following sections provide general guidance on the sizing of the subframe.

6.3.1 Brackets – instructions independent of the material

Brackets must be chosen with specifications ensuring that they remain elastic and that the maximum deformation under vertical load is compatible with the cladding specifications.

The vertical span between the brackets must be determined in accordance with the rules in force in the location where the facade will be installed. This will depend on the permanent and variable loads which the facade is subjected to.

In general, it being understood that the vertical spans between the brackets must be calculated and prescribed by the Project Architect of the facade, the following maximum indicative values derived from operating practice should be considered:

Subframe material	Vertical span between the brackets Suggested maximum value (m)
Wood	1
Metal (Steel and Aluminum)	1.35 (story height 2.7 m) 1.50 (story height 3 m)

Table 7 – The maximum value of the spans between brackets depends on the material of the subframe and the story height.

For metal subframes the span between the brackets will generally be between 750 mm and 1500 mm. Verifications of the vertical loads and horizontal wind load, both positive and negative, may require a significant reduction to these spans. In any event, their value will be prescribed by the Project Architect.

Regardless of the material they are made of, the brackets can be two types:

- load-bearing brackets, which for the purposes of the calculation are considered to primarily support the facade's own weight
- retaining brackets, which for the purposes of the calculation are considered to primarily support the horizontal stresses which the cladding panels and ventilated facade are subjected to overall. These brackets are also used to allow the subframe to absorb positive or negative expansion due to changes in temperature and humidity

In general, unless the Project Architect determines otherwise, a support bracket must be used for each individual battens/profiles' component. Attention must also be paid to the distribution of the load-bearing brackets on the facade so that the deformations induced by thermo-hygrometric conditions during its working life can be absorbed without creating hazardous stress accumulation points. For this reason, it is advisable to align the bearing brackets of adjacent profiles horizontally.

In addition, in order for the subframe to perform better over its working life, it is good practice to arrange the brackets so that they are secured to the battens/profiles alternately on the right and left, as in the image below.

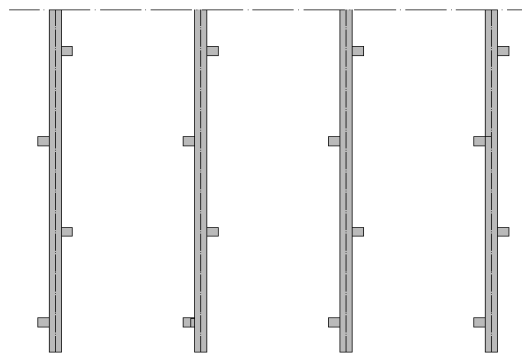

Image 6 – It is good practice to arrange the brackets of each batten/profile alternately

Unless otherwise necessary and justified, the position of the load-bearing brackets should be in the center of the profile.

Experience suggests that deformation of the subframe should be restricted to a minimum. For this reason, the maximum deflection of the batten/profile between two brackets d_{max} , due to the expected horizontal loads, must be $d_{max} \leq 1/200$ for the span between the brackets "i".

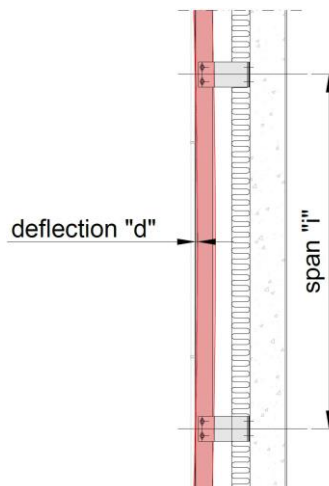

Image 7 – The maximum deflection of the battens/profiles between two brackets d_{max} must be $\leq 1/200$ for the span between the brackets "i"

The Project Architect must check that the maximum permissible deformations for the subframe are compatible with the Silbonit cladding panels.

6.3.2 Wooden battens/Metal profiles and expansion joints – instructions independent of the material

As a whole, the battens/profiles of a subframe must form a vertical plane for laying the cladding. The flatness and verticality of the surface, made up by the battens/profiles and designed to support the cladding panels, can be guaranteed by adjusting the length of the brackets during installation. When installing, it is advisable to check the verticality and coplanarity of the beams between adjacent battens/profiles. The Project Architect will determine which checks must be carried out, both during and after installation, prescribing for example the maximum permissible deviation between adjacent battens/profiles.

The value of the horizontal span between the vertical components of the subframe is normally limited to a maximum value of 600 mm. This span determines the maximum deformation of the cladding panels and must also be calculated taking this aspect into account. Values higher than the maximum values indicated may be specified at the Project Architect's discretion after the calculation and subsequent sizing of the subframe. Verifications of the loads for each specific application, such as the vertical loads and horizontal wind loads (both positive and negative) may require a reduction in the span distances compared to the maximum recommended values.

Subframe material	Horizontal span between subframe profiles Maximum value (mm)
Wood	600
Steel	600
Aluminum	600

Table 8 – Maximum span between subframe profiles

Depending on their width, the cladding panels can be secured on two or more vertical profiles. The whole length of the vertical profiles will be visible if they are positioned along the joints. They will be hidden by the panel if they are positioned between the open vertical joints.

As a rule, the maximum length of the vertical profiles should generally be the same length as the story height; however, it is the Project Architect's responsibility to provide this specification taking into account the different expansion coefficients of the individual materials. **Expansion joints** must be fitted between one vertical profile and the next. They must be positioned along the horizontal joints of the cladding. The size and specifications of the joints must be calculated and prescribed by the Project Architect, taking into account the characteristics of the material chosen for the subframe.

The following image shows two vertical sections, the first with an example of how not to secure the panels near an expansion joint between one subframe vertical profile and the next, whilst the second shows a correct solution for the same detail.

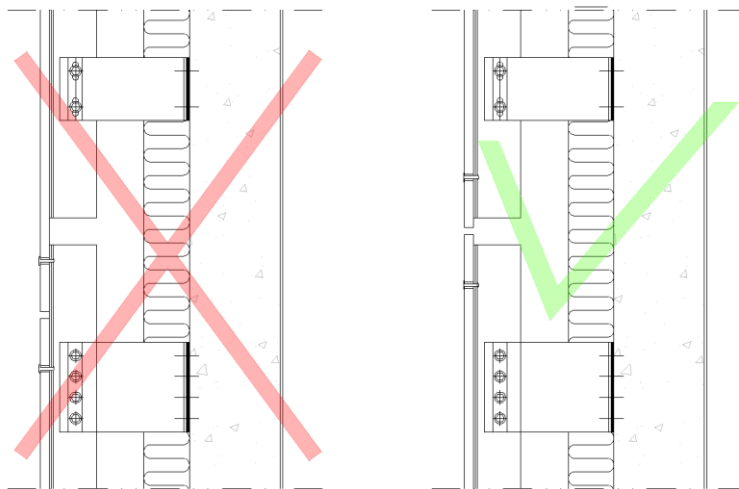

Image 8– Vertical sections – Examples of incorrect and correct arrangement of cladding panels along an expansion joint between one subframe vertical profile and the next

To protect the vertical profiles from atmospheric agents, a gasket made of suitable material must be applied. The width of the gasket must be wide enough to cover the entire vertical profile.

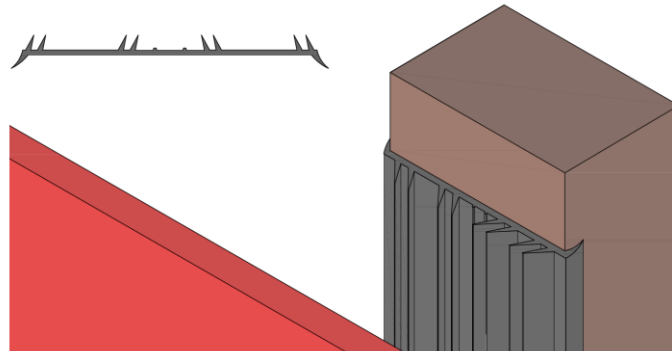

Image 9– Example of a gasket fitted over the entire surface of the vertical profile

If the load-bearing structure has expansion joints, the facade must be designed so that no panels are fixed across those joints. The following image shows two horizontal sections, the first with an example of how not to secure the panels, and the second with a correct solution for the same detail.

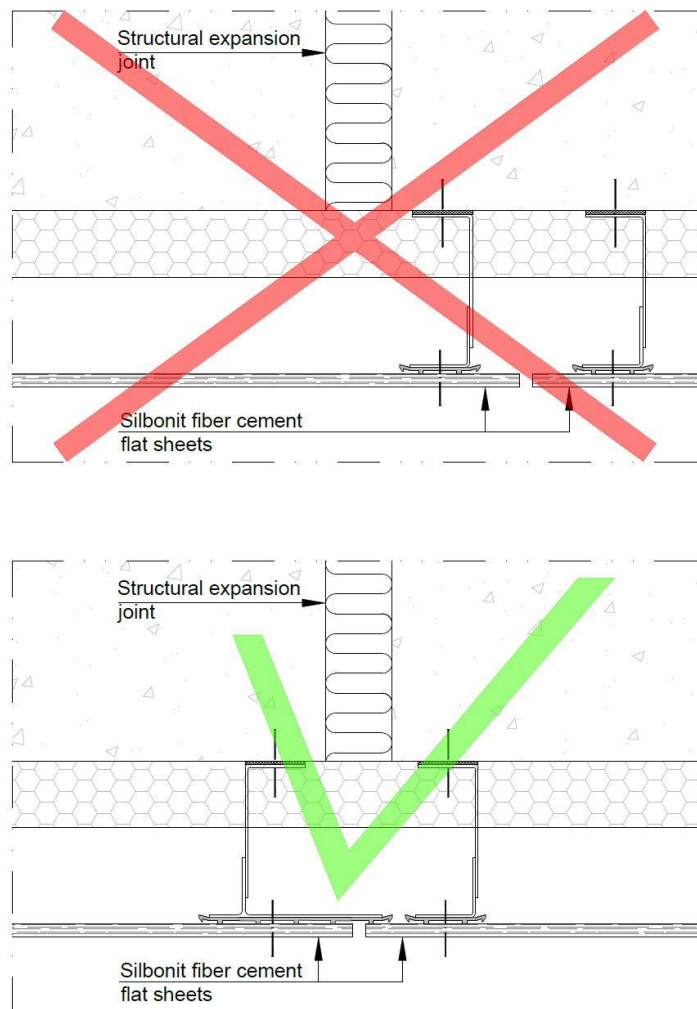

Image 10– Horizontal sections – Examples of incorrect and correct arrangement of profiles and cladding panels along an expansion joint of the supporting structure

Table 9 shows, **by way of example only and in compliance with the maximum deformation of the profiles**, the calculated value of the vertical span between the brackets, varying in terms of:

- the depression stress due to wind
- the material chosen for the profiles
- the horizontal span between them

The calculations were carried out for two span values between the profiles (450 mm and 600 mm), for wooden and steel profiles and with the static arrangement of the panel on 3 supports. The steel bracket used in the calculations has dimensions of 60 mm x 50 mm x 80 mm, thickness of 2.5 mm (see ETA 17-0318). For clarity, in this section vertical span refers to the distance between the brackets, while horizontal span refers to the distance between the profiles of the subframe.

The table is not a substitute for subframe sizing calculations, but serves as an example to understand how the values of the spans between the profiles vary under the four stress conditions in the two typical cases of subframes highlighted. The complete specifications of the materials used for the sample calculations (for kits with steel and wooden subframes respectively) can be found in ETA 17-0318. In the ETA, kits with the aluminum subframe were also tested, which were not considered for these sample calculations.

Note: The values in the table within parentheses indicate the spans that the materials in the two examples are able to withstand. When these values are higher than the maximum values recommended by SIL, they have been placed next to the maximum suggested values.

Wind pressure ² (kN/m ²)	Maximum vertical span between brackets (mm) (with $d_{max} \leq 1/200$)			
	Steel subframe		Wooden subframe	
	Galvanized steel profiles S235 Z275 Omega section 50 x 60 x 50 x 60 x 50 mm thickness 15-10 mm		Wooden battens Section length 70 mm thickness 50 mm	
	Horizontal span between profiles		Horizontal span between profiles	
	450 mm	600 mm	450 mm	600 mm
-0.87	(1635) - 1500	1225	(1635) - 1000	(1225) - 1000
-1.39	1020	765	(1020) - 1000	765
-1.91	745	555	745	555
-2.43	585	435	585	435

Table 9 – Examples of the value of the vertical span between the brackets of the subframe depending on the wind pressure, the material of the profiles, and the horizontal span between them.

After completing the calculations, the Project Architect will choose which values to prescribe for the spans between the brackets. In the following sections, general guidelines are given for wooden, steel, and aluminum subframes to assist in their sizing.

6.3.3 Wooden subframe

The wooden subframe is usually made of beams with a rectangular cross-section. The specifications for those beams must be prescribed by the Project Architect. The beams will be secured to the load-bearing wall using brackets.

The following table summarizes, by way of example, the minimum requirements for wood given in ETA 17-0318.

Wooden subframe	Minimum wood requirements
Strength class	≥ C18 – as per EN 338:2011 Structural timber – strength classes
Durability	Class 3 – as per EN 335-2:2007 Durability of wood and wood-based products
Production process	Autoclave level 5
Humidity control on delivery	≤ 18%
Humidity variation between parts of the same supply	≤ 4%

Table 10 - Minimum requirements for the wooden subframe material as per ETA 17-0318

² Wind pressure P (see NTC2018 section 3.3.4)

6.3.3.1 Considerations for the geometry and dimensions of the vertical beams of the wooden subframe

Depending on their width, the cladding elements can be placed on two or more beams.

The suggested minimum width W of the beams along the joints of the panels is 140 mm (2 x 70 mm) and the minimum width W of the intermediate support beams is 70 mm. Smaller sizes may only be used if calculated at the discretion of the Project Architect. The minimum suggested thickness is 50 mm.

In order to prevent the beams from deforming due to torsion of the wood, the elongation E of the cross-section of the individual beams should be between 0.5 and 2. (This is defined as the ratio between the thickness T and the width W of the section, $E = T/W$, and with the suggested minimum dimensions of $50/70 = 0.7$.)

The table below summarizes the minimum geometrical specifications of the beams of a single-frame wooden subframe.

In the kits described in ETA 17-0318, a single frame fixed to the load-bearing wall with steel brackets was used.

Wooden beams	Minimum width W (mm)	Thickness T (mm)	$E = T/W$
Beams along the vertical joints	$W \geq 140$ (2 x 70)	$T \geq 50$	$0.5 < E < 2$ E is calculated for the section of the individual beam, e.g. $T = 50$ $W = 70$
Intermediate supporting beams	$W \geq 70$	$T \geq 50$	

Table 11 – Minimum section dimensions

The width of the beams, as shown in the image below, must be sufficient to guarantee:

- the envisaged opening “ g ” for the joints between the cladding panels
- compliance with the minimum distance “ b ” of the fastenings from the edges of the panels
- compliance with the minimum distance “ c ” of the fastenings from the sides of the slats

The beams must also be sufficiently thick to guarantee that their maximum deflection due to wind load (both positive and negative) has a value $d_{\max} \leq 1/200 i$, where “ i ” is the distance between the brackets.

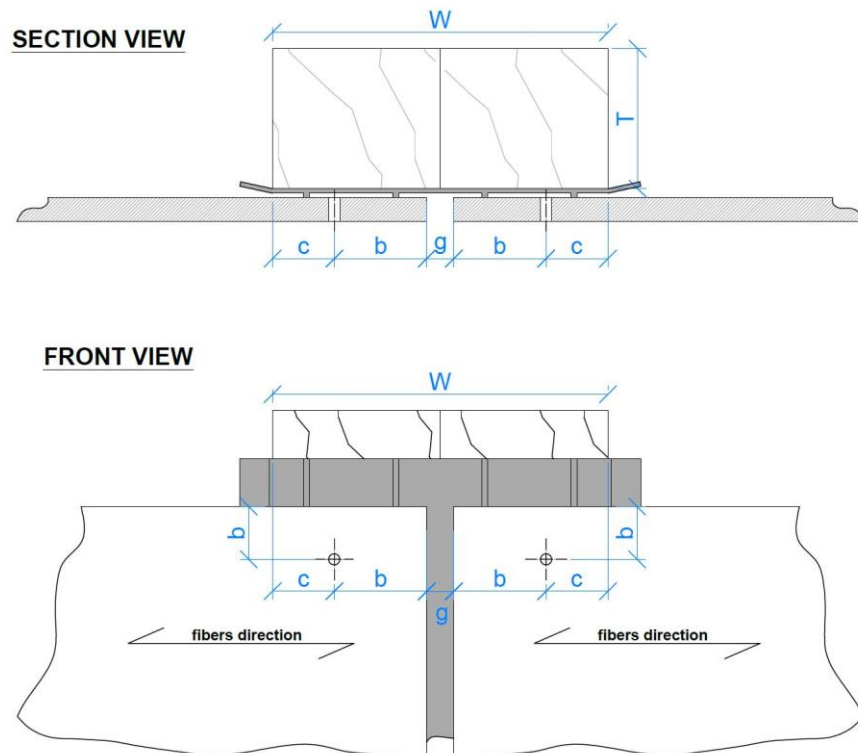

Image 11 – Geometrical specifications of the cladding required to determine the width of the wooden beams of the subframe

The following table provides a summary of the geometrical specifications of the cladding of a ventilated facade that affect the width W of the vertical wooden beams of the subframe.

Geometrical specifications of the cladding of a ventilated facade that determine the width W of the wooden battens		(mm)
Width of the vertical joints between the cladding panels		$8 \leq g \leq 10$ mm
Minimum distance of the fastenings from the edge of the cladding panels	If parallel to the direction of the fibers	$b \geq 45$ mm
	If perpendicular to the direction of the fibers	$b \geq 25$ mm
Minimum distance of the fastenings from the nearest edge of the profile		$c \geq 20$ mm
Maximum deflection between two brackets due to pressure or depression exerted by wind		$d_{\max} \leq 1/200$ i

Table 12 – Geometrical specifications of the cladding that determine the width W of the vertical wooden beams along the joints between the panels

The maximum distance of the fastenings from the edge of the panel must not exceed 65 mm, where the width of the underlying beam allows.

NOTE: When determining the distance of the fastenings from the edge of the cladding panels, the Project Architect must ensure that value “b” in the direction parallel to the fibers and “b” in the direction orthogonal to the fibers are not equal to each other, while also remaining within the constraints shown in the table. A configuration failing to do so would produce a state of tension in the panel that could cause 45° cracks at the fastening, and consequently cause the edge of the panel to detach.

The beams are secured to the supporting structure using galvanized steel brackets, also called support joints or braces. For the characteristics of the metal brackets, see those used in ETA 17/0318 kits, for example. They must guarantee:

- that the brackets remain in an elastic phase under load
- that they remain durable in the conditions they will be subjected to over their working life (e.g. resistance to corrosion)

During installation, the flatness and verticality of the surface formed by the profiles (which will support the cladding panels) must be guaranteed.

The following image shows an example of a ventilated facade package with a single-frame wooden subframe.

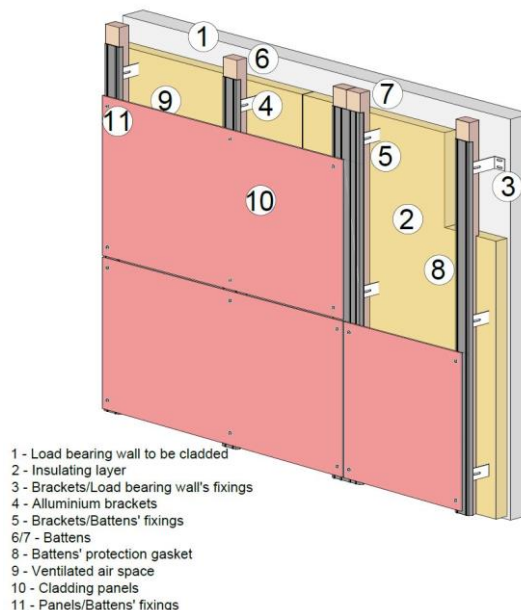

Image 12 Example of a ventilated facade package with a wooden subframe, mounted on the load-bearing wall

As a rule, the maximum span between brackets in the vertical direction should be kept at ≤ 1 m. Verifications of the loads for each specific application, such as vertical loads and horizontal wind load (both positive and negative), may result in this span needing to be reduced further. The Project Architect may, however, having completed the calculations and at their own discretion, evaluate spans greater than 1 m in view of the results of the calculations.

Attention should be paid to the risk of corrosion of the metallic elements (such as brackets and the fastenings) when they come into contact with substances based on copper, mercury, or other components used to improve the natural durability of wood.

6.3.4 Galvanized steel subframe

The steel subframe must be made of vertically arranged profile elements secured to the load-bearing wall (which will be cladded) using brackets made of the same material.

The profiles and brackets must be made of hot-dip galvanized steel.

The steel must be at least type S235 as per EN 10025 *Hot-rolled products of structural steels* and EN 10027 *Designation systems for steels*, hot-dip galvanized steel with minimum Z275 specifications for both the subframe profiles and the brackets. The thickness "t" of the steel must be at least 15/10 mm for the profiles and 25/10 mm for the brackets.

The steel subframe can be comprised, for example, of Omega and L transversal section profiles, and of brackets with the minimum specifications suggested below, also found in ETA 17-0318. These dimensions should be considered as minimum values, unless sizing calculations permit them to be lower.

Subframe element	Minimum dimensions (mm)	Minimum specifications of materials
Ω profile	50 x 60 x 50 x 60 x 50 mm t = 15/10	S235 Z275 t = 15/10
L profile	50 x 60 mm t = 15/10	S235 Z275 t = 15/10
Brackets	50 x 60 x 80 mm t = 25/10	S235 Z275 t = 25/10

Table 13 – Geometrical specifications and minimum dimensions of galvanized steel subframe

During installation, the flatness and verticality of the surface formed by the profiles (which will support the cladding panels) must be guaranteed.

The following image shows an example of a ventilated facade package with a galvanized steel subframe.

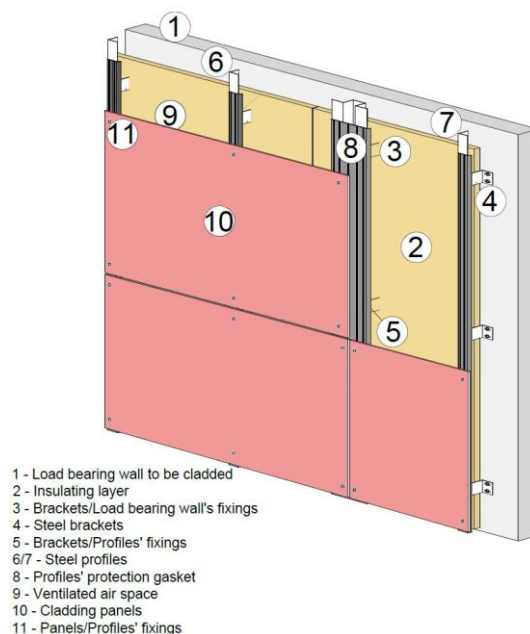

Image 13 – Example of a ventilated facade package with a steel subframe, mounted on the load-bearing wall

The following table provides a summary of the geometrical specifications of the cladding of a ventilated facade that determine the width W of the metal profiles of a subframe. The values apply to both steel and aluminum profiles in the following section.

Geometrical specifications of the cladding of a ventilated facade that determine the width W of the metal profiles (steel and aluminum)		(mm)
Width of the vertical joints between the cladding panels		$8 \leq g \leq 10$ mm
Minimum distance of the fastenings from the edge of the cladding panels	If parallel to the direction of the fibers	$b \geq 45$ mm
	If perpendicular to the direction of the fibers	$b \geq 25$ mm
Minimum distance of the fastenings from the nearest edge of the profile		$c \geq 15$ mm
Maximum deflection between two brackets due to pressure or depression exerted by wind		$d_{\max} \leq 1/200 i$

Table 14 – Geometrical specifications that determine the width W of the metal profiles along the joints between the panels

The maximum fastening distance from the edge of the panel must not exceed 65 mm, where the width of the profile below allows.

6.3.5 Aluminum subframe

The aluminum subframe must be made of vertically arranged aluminum profile elements secured to the load-bearing wall (which will be cladded) using brackets made of the same material.

The following table shows the layout of the subframe that has been used in the ETA 17-0318 kits. The dimensions of the components can be found in ETA 17-0318 and should be considered as minimum values, unless the sizing calculations permit them to be lower.



Type	Material	Geometrical specifications (mm)	Subframe elements
Supporting bracket	Aluminum + base using thermal insulation material	100 x 45.3 x 80-260 mm	
Retaining bracket	Aluminum + base using thermal insulation material	70 x 45.3 x 80-260 mm	
L profile	Aluminum	45 x 45 x 2.3 mm	
Asymmetrical T profile	Aluminum	130 x 45 x 2.3 mm	

Table 15 – Geometrical specifications of the subframe elements used in the ETA 17-0318 kits

For the geometrical specifications that determine the W width value of the metal profiles, see Table 14.

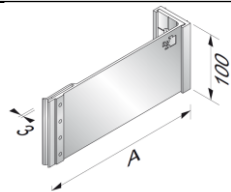
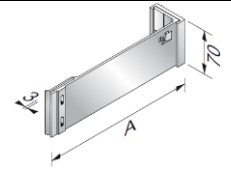
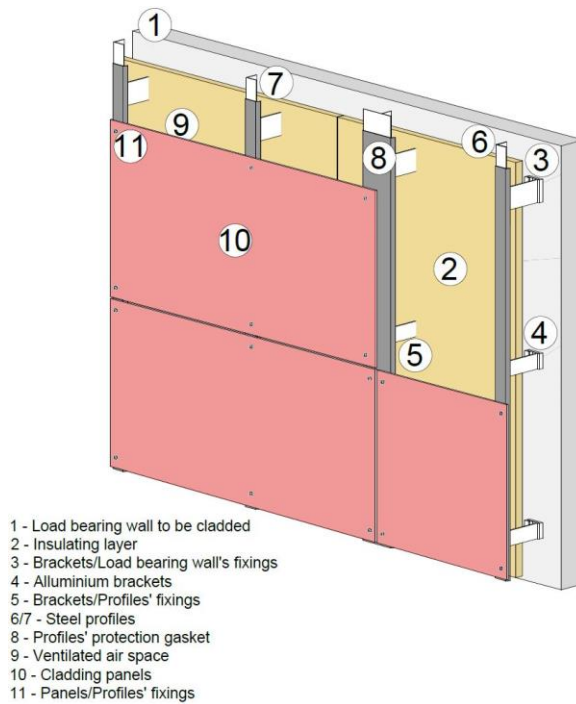

Image 14 – Example of a ventilated facade package with an aluminum subframe, mounted on the load-bearing wall. The insulation layer is optional.

In ETA 17-0318, all of the specifications of kits with an aluminum subframe can be consulted.

During installation, the verticality and flatness of the external surface of the profiles (which will support the cladding panels) must be guaranteed.

6.4 Ventilated cavity

A ventilated cavity must be created between the outer wall of the building and the rear surface of the cladding. An air barrier is formed in the cavity which, fed by the lower openings of the facade, moves upward in the direction of the openings that must be provided at the top, as part of the facade's coping. The air flow in the cavity is designed to restrict moisture resulting from any rainwater that enters behind the cladding, and from condensation of water vapor that reaches the ventilated chamber from inside the building. In order for the air in the cavity to work effectively, it must be ensured that:

- its section must **not** be restricted along the protruding elements (such as the profiles)
- its section must **not** be restricted by any insulating layers becoming deformed in varying hygrometric conditions, or because of incorrect installation, or selection of inappropriate materials
- any accessories used to vertically compartmentalize the air barrier must **not** prevent it from flowing freely
- the inlet and outlet of the ventilation openings (both lower and upper) must have sufficient surface area

To ensure proper ventilation, the width of the ventilated cavity must be sized while taking the height H of the ventilated facade into account.

The following table shows the minimum cavity thicknesses depending on different H values.

Ventilated facade height H (m)	Minimum thickness of ventilated air space (mm)
$H \leq 10$	30
$10 < H \leq 20$	40
$20 < H \leq 50$	50

Table 16 – Thickness of the ventilated air space depending on the height of the wall to be cladded

One prerequisite for proper ventilation concerns the openings at the base and top, which must be suitably sized by taking into account any grille elements.

Where grille elements are used to prevent rodents or insects from entering, the ventilation surface must be duly compensated.

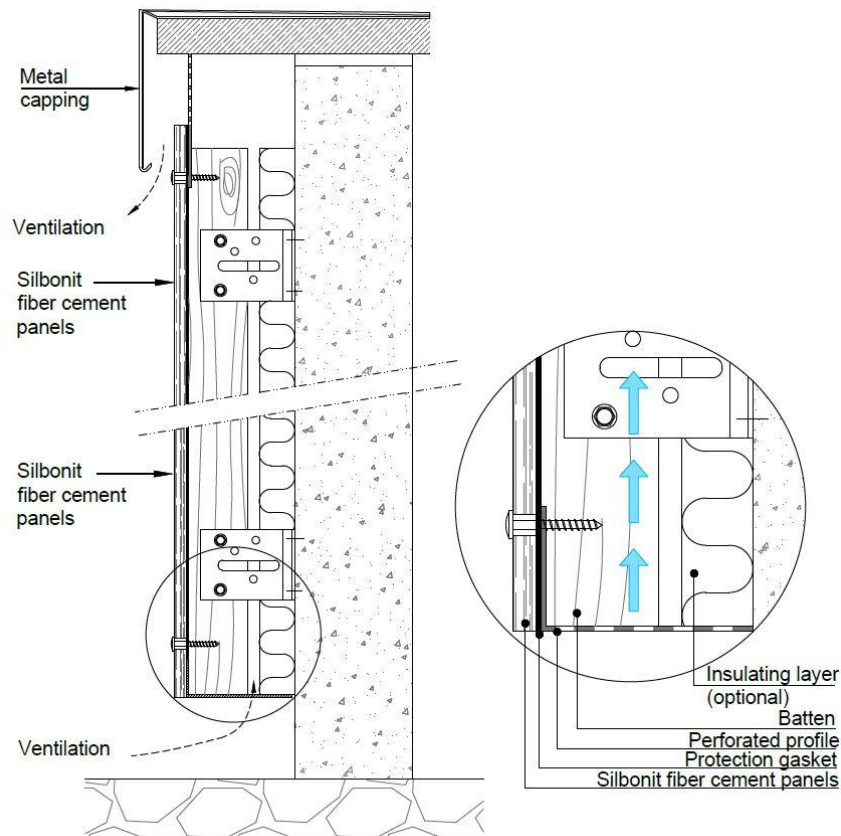

Image 15 – Section of the base and coping at the top of the facade with anti-intrusion grilles and protective flashings on the coping of the cladding.

If necessary, the cavity can be partitioned with suitable horizontal and/or vertical barriers in order to separate the circulating air space and thereby confine any possible spread of a fire or the effects of wind. If these barriers are used, they must not impede the free circulation of air within the cavity in any way.

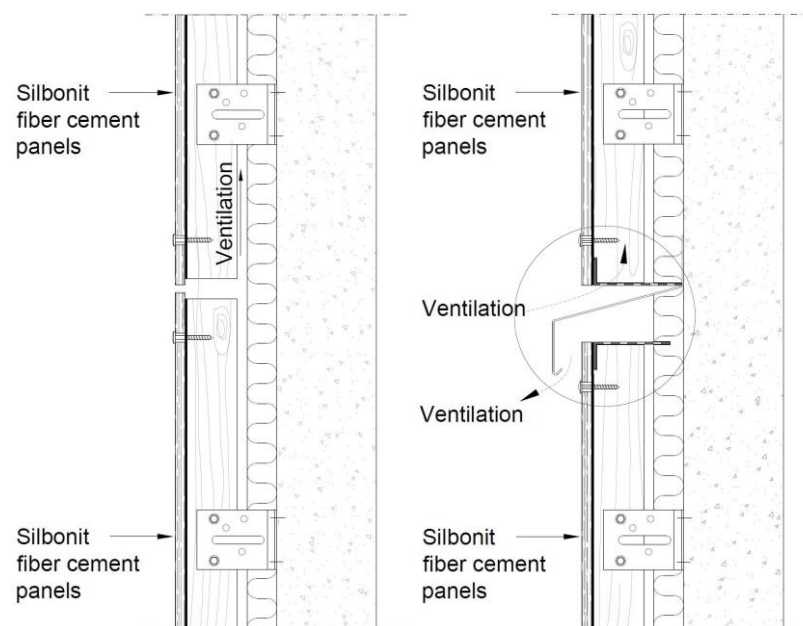

Image 16 – Example of a continuous and partitioned ventilated cavity on a wooden subframe. The flashings used to partition the air barrier must never compromise the free flow of air. The layer of insulation material is optional.

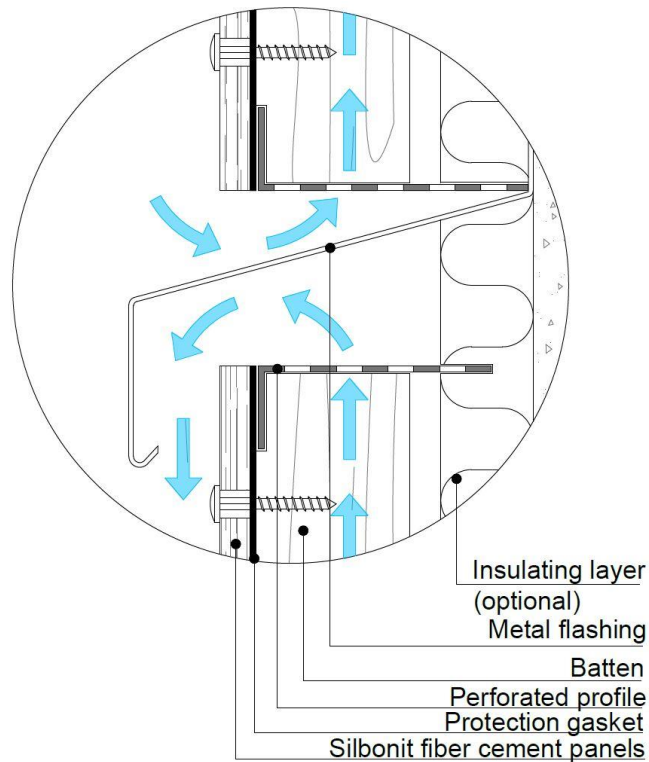

Image 17– Detail of a partition in a ventilated cavity created using an air barrier

6.5 Level 2 and Level 3 fastenings

The Project Architect of the ventilated facade must consider the stresses that the facade will be subjected to during its working life and installation when determining the Level 2 and Level 3 fastenings.

The fastenings used for a ventilated facade clad with Silbonit fiber-cement flat panels must allow assembly to be completed entirely with mechanical operations.

This means that fastening systems such as the following **may not** be used:

- chemical fastenings (e.g. silicone or polyurethane adhesives and sealants)
- fastenings that rely on Velcro
- fastenings that rely on gaskets

6.5.1 Level 2 fastenings

In this document, Level 2 fastening are the ones connecting the profiles of the subframe to the metal brackets. In general, screws or rivets can be used for this purpose. The following table shows, by way of example, the type of fastenings that should be used depending on the material that the profiles and brackets are made from.

Further details on the fastenings used in the test kits are given in ETA 17-0318.

Examples of Level 2 fastenings	Profile material	Bracket material	Fastening type
1	Wood	Steel	Stainless steel screw
2	Steel	Steel	Stainless steel screw
3	Steel	Steel	Stainless steel rivet
4	Aluminum	Aluminum	Stainless steel screw

Table 17 – Level 2 fastenings

6.5.2 Level 3 fastenings

Level 3 fastenings are the ones that join the cladding panels to the profiles of the substructure.

Screws or rivets can be used for this purpose. Fastenings with colored heads are available which can match the color of the panels.

Silbonit fiber-cement panels must always be drilled before installation; they must never be fixed to the subframe profiles using self-drilling screws.

The following table shows, by way of example, the type of fastening that should be used to join the fiber-cement panels to the profiles of the subframe, depending on the material that the profiles are made from.

Examples of Level 3 fastenings	Panel on subframe made of	Fastening type
1	Wood	Stainless steel screw
2	Steel	Stainless steel screw
3		100% stainless steel rivet
4	Aluminum	Aluminum/stainless steel rivet

Table 18 – Level 3 fastenings

In general, the maximum distance between Level 3 fastenings must always be ≤ 600 mm, while the minimum distance must always be ≥ 300 mm.

In general, the distance between the fastenings must be calculated so as to limit the deformation of the panel between two fastening points to within 1/200 of their spans.

6.5.2.1 “Fixed point” and “sliding point” fastenings and their holes

Level 3 fastenings can be either “fixed point” or “sliding point”. The fixed fastenings are intended to withstand mainly vertical loads (e.g. the weight of the cladding panels themselves), while sliding fastenings are intended to withstand mainly horizontal loads (e.g. depression due to wind) and to allow the panels to deform in line with thermo-hygrometric variations. Their calculation should therefore be carried out under these assumptions.

The “fixed” point should preferably be located in the central area of the panel to ensure it remains in the intended position, and must allow dimensional variations to be distributed throughout the panel. For this reason, the diameter of the hole of a fixed point must be equal (considering the appropriate mounting tolerances) to that of the fastenings (screws or rivets).

The position of the Level 3 fixed point is dependent on the position of the subframe’s retaining brackets: out of all the brackets supporting the profile, the retaining bracket must be the one closest to the fixed point.

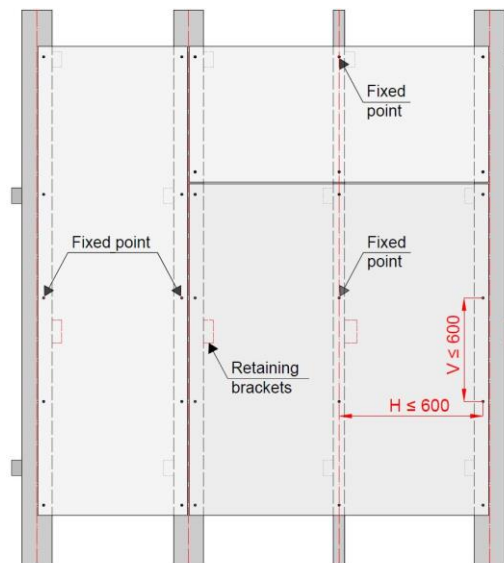

Maximum horizontal distance between "level 3" fixings: $H \leq 600$ mm
Maximum vertical distance between "level 3" fixings: $V \leq 600$ mm

Image 18 – Example of cladding with Silbonit fiber-cement panels. The retaining bracket shown in red should be as close as possible to the fixed point of the panel.

If the geometry of the panel does not allow it to be maintained in the intended position, two fixed points can be made. These must be aligned and positioned on two adjacent profiles, but never on the same profile.

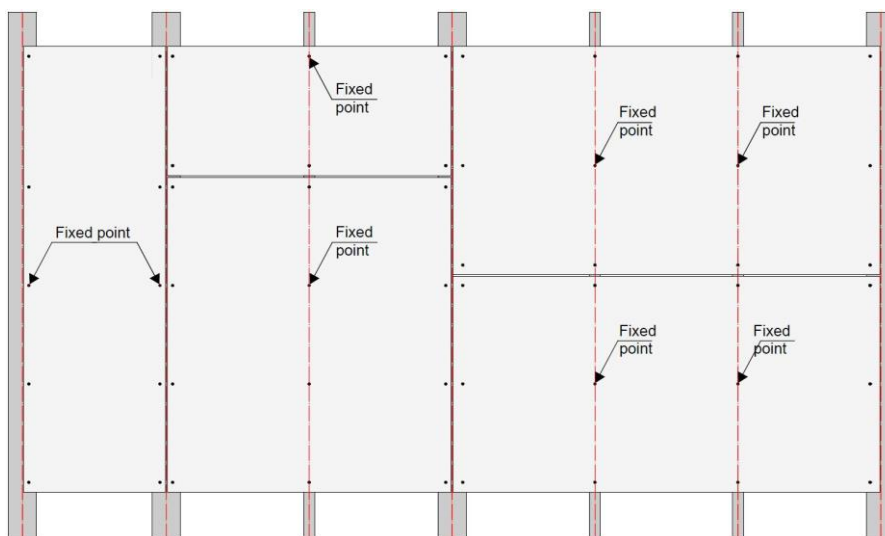

Image 19– Example of cladding with Silbonit fiber-cement panels. In some cases, the geometry of the panel and the facade layout may require two fixed points.

In order to allow the panels to deform, the holes for “sliding point” fastenings must have a larger diameter than the holes for the “fixed point” fastenings and in any case, larger than the diameter of the screw.

The Project Architect can also require for all the holes to be made with the same diameter. If that is the case, the largest of the two diameters will be chosen, i.e. the one selected for “sliding point” fastenings. To reduce the diameter of the holes to the diameter set for the fixed points, suitable metal bushings can be used.

Using a single diameter for all the Level 3 holes can reduce errors when positioning the fixed points during installation.

In the table below, for the kits tested for ETA 17-0318, the diameters of the holes for “fixed point”, “sliding point”, and metal bushings are given as examples. Further information is available in ETA 17-0318.

Panel thickness (mm)	Hole diameter (mm)	Bushing for fixed point
8, 10, 12	9.5	External Ø 9.4 mm Internal Ø 5.1 mm

Table 19 – Level 3 fastenings. Example of the diameter for fixed point and sliding point holes



Image 20– Example of metal bushing that should be used to make the fixed points when the holes on the panels are all made with the same diameter as for the sliding points.

N.B.: in case of galvanized steel subframe and level 3 stainless steel screw the fixed point has to be done drilling a Ø 5,6mm hole into the fiber cement panel instead of using the metal bushing (stainless steel screw is Ø 5,5mm).

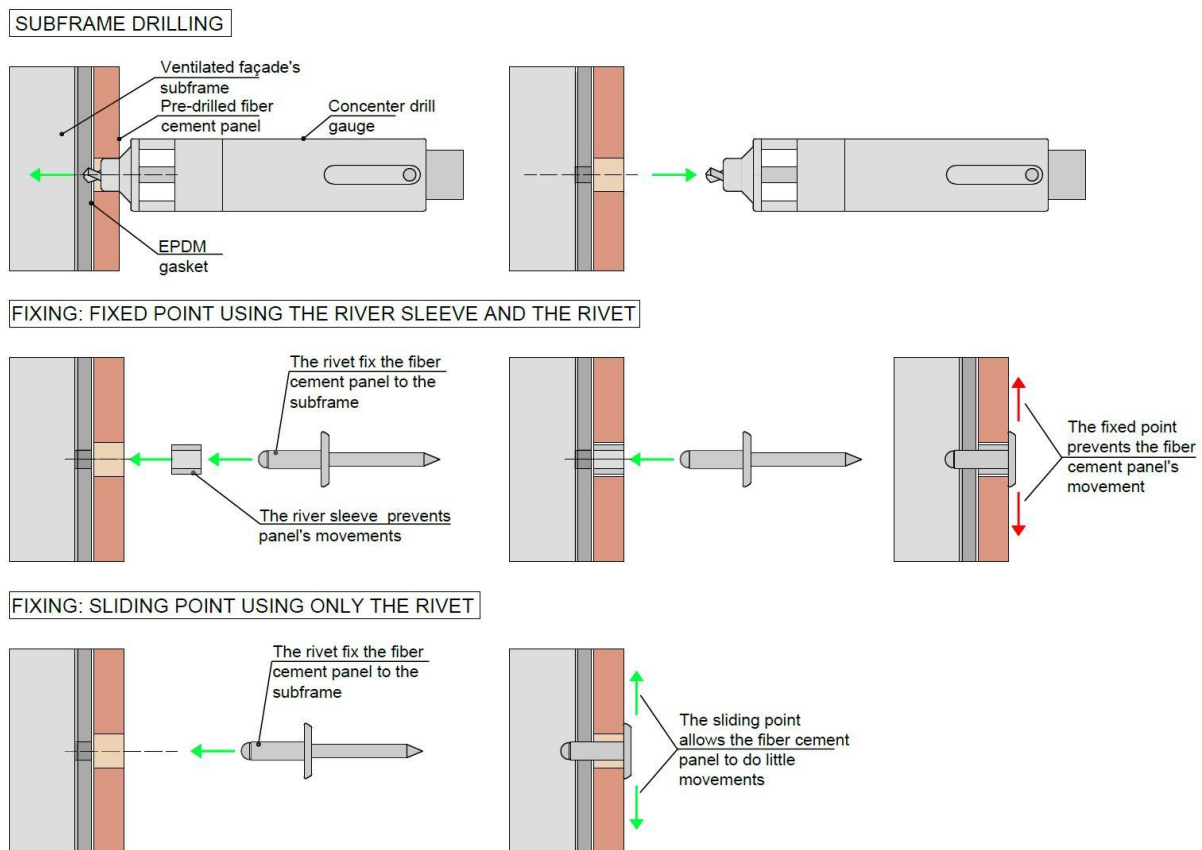

Image 21 – Example of steps to fix Silbonit fiber-cement panels. The panels are pre-drilled with holes that all have the same diameter of 9.5 mm. The example shows how the diameters of the holes for the fixed points are reduced using suitable metal bushings.

Where wooden battens are used for the subframe, attention should be paid to the risk of corrosion of the metal elements (such as the brackets and fastenings) when they come into contact with substances based on copper, mercury, or other components used to improve the natural durability of the wood. Some examples of the maximum span between Level 3 fastenings and between the profiles of a wooden subframe are shown in the following section.

6.5.2.2 Example calculations for the spans between Level 3 fastenings

Table 22 provides some examples that show how the maximum span between the fastenings varies depending on different stresses on the cladding.

These calculations were made for the kit with wooden subframe described in ETA 17-0318. The specifications for that kit are summarized as follows:

- Silbonit flat panels, 8 mm in thickness, fitted with the fibers in the horizontal direction
- wooden subframe, with 600 mm span between the profiles
- fastenings: TW-S-D12 screws Ø 4.8 L=38
- panels on at least 4 supports

The maximum distances between **Level 3** fastenings have been calculated according to three variables:

- reference wind speed “ v_r ”
- maximum height of the building
- type of environment in which it is located³

For the variables, four values have been chosen to represent four different typical situations.

The values of the (negative) pressures have been calculated in accordance with Italian regulations⁴. Negative pressures have been considered in view of their role in the function of the fastenings.

Reference wind speed ⁵ v_r (km/h)	90				97				106				113			
Reference kinetic pressure ⁶ q_r (kN/m ²)	0.39				0.45				0.54				0.62			
Building height (m)	5	10	15	20	5	10	15	20	5	10	15	20	5	10	15	20
Type of environment	Maximum vertical span between Level 3 fastenings (distance between wooden battens of 600 mm)															
Big city	640	640	610	575	595	595	560	520	530	530	495	455	480	480	450	415
Small town	605	570	515	480	555	505	460	430	495	465	420	385	450	425	375	355
Countryside with obstacles	575	505	465	440	515	445	410	385	480	430	385	365	445	385	355	330
Open countryside	555	480	450	430	500	435	400	375	475	405	370	350	440	370	340	320

Table 22 – Maximum distances between Level 3 fastenings depending on the environment, building height and wind speed, provided that the profiles are laid with a span of 600 mm.

Table 23 shows, for the predetermined pressure values, the maximum horizontal distance between the profiles for static layouts with two, three, and four supports, and the corresponding maximum vertical distance between the Level 3 fastenings. The illustrative calculations were made for a panel with a thickness of 8 mm in a central position of the facade. When performing their calculations, the Project Architect must carefully consider the position of the panel on the facade, given that certain positions are subjected to more stress than others (such as along the edges of a facade and the corners of the building).

³ Table 3.3.III – Soil roughness classes, NTC2018 section 3.3.7

⁴ NTC 2018 and CNR DT207

⁵ v_r = reference wind speed, see NTC2018 section 3.3.2

⁶ q_r = reference kinetic pressure, see NTC2018 section 3.3.6

Note: The values in the table within parentheses indicate the spans that the materials in the two examples are able to withstand. When these values are higher than the maximum values recommended by SIL, they have been placed next to the maximum suggested values.

Wind pressure (kPa)	Maximum horizontal span between profiles			Maximum vertical span between Level 3 fastenings		
	Number of profiles (panel supports)			Number of profiles (panel supports)		
	2	3	4	2	3	4
-0.87	550	(740) 600	(680) 600	(630) 600	495	590
-1.39	425	(630) 600	585	560	435	515
-1.91	470	570	525	500	385	460
-2.43	390	525	485	460	350	420

Table 23 – Examples showing how the maximum distance between the profiles of the wooden subframe varies according to the wind pressure and the number of panel supports.

After calculating the distance between the profiles and the panel fastenings, the Project Architect will also consider the final aesthetics of the facade to set the distance. If the fastenings are visible, for example, it may be preferable to have more fastenings spaced evenly than to have the minimum number of fastenings possible.

6.6 Cladding panels

Ventilated facade cladding with Silbonit fiber-cement panels is open-joint cladding. Open joints are vertical and horizontal spaces between the edges of adjoining panels and are created when the cladding is fitted.

The open joints allow atmospheric agents to pass through and improve the air flow of the ventilated cavity. Their width (whether horizontal or vertical) can vary from 8 mm to 10 mm.

The panels can be mounted with the longest side vertically or horizontally, with continuous or staggered joints. The following image shows examples of continuous joint and staggered joint layouts, with panels fitted horizontally and vertically, respectively.

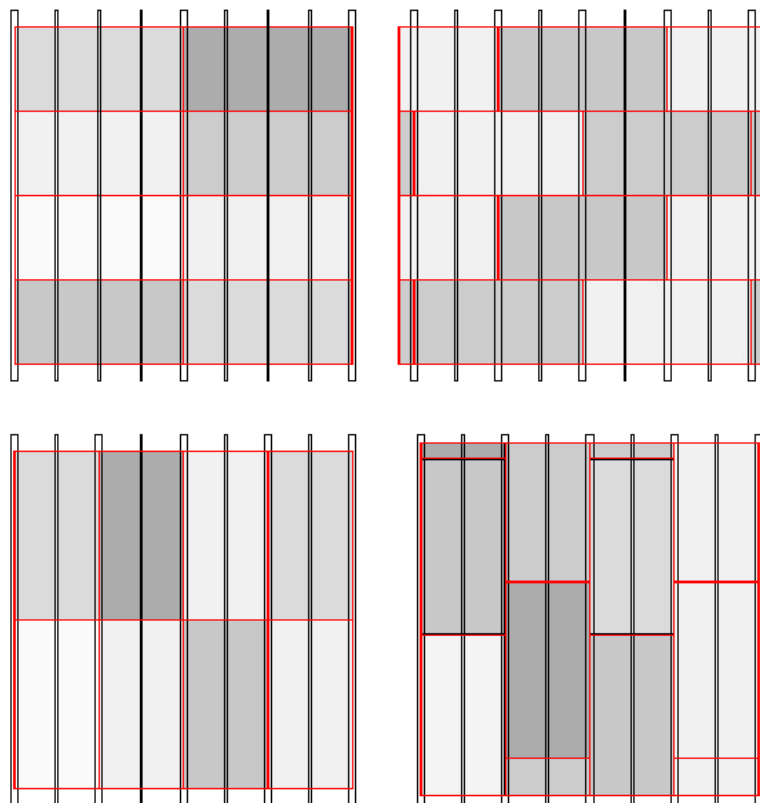

Image 22 – Examples of continuous joint and staggered joint layouts, with panels fitted horizontally and vertically, respectively.

The configuration for fitting the panels and the final layout of the joints must be decided by the Project Architect, with due consideration that:

1. the panels have different resistances when stressed in parallel to the fibers or in an orthogonal direction to them – the fitters must also be duly informed of this
2. from a functional point of view, there must be proper rainwater runoff over the entire surface of the cladding, and localized stagnation must be prevented
3. the aesthetic appearance of the cladding also depends on the smoothing direction of the surface of the panels; this issue does not arise if the panels belong to the Silbonit Pigmenta product range

Each panel must be vertically fixed to a single profile of the subframe to allow the best possible distribution of deformations. The left side of the following image shows an example of the correct way to secure the panels on the profiles, while the example on the right side should never be followed.

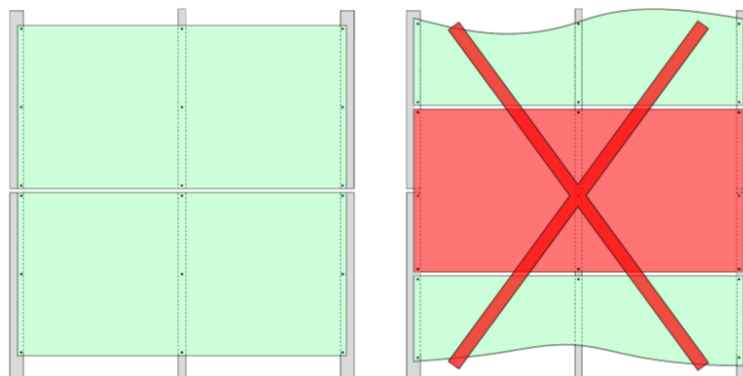

Image 23 – Left: example of a correct way to secure Silbonit panels, with the horizontal joint of the cladding aligning with the expansion joint of the subframe profiles. Right: example of an incorrect way to secure the Silbonit panels, with a cladding sheet secured to two profiles.

In terms of smoothing, the panels are smoothed in the same direction as the fibers. The smoothing direction can impact the appearance of the cladding.

7 Cladding a facade with Silbonit fiber-cement panels

7.1 Singular points – examples of solutions for certain singular points of the facade packages

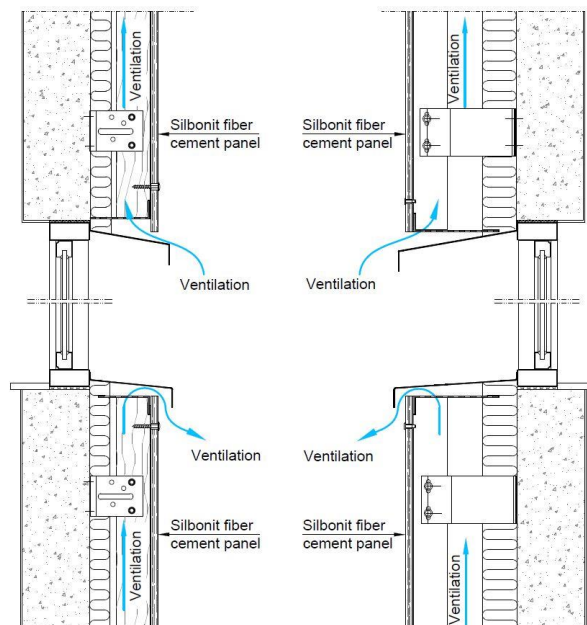

Image 24 – Example of a section of a ventilated facade package along a window. Wooden subframe on the left and aluminum subframe on the right, both cladded with Silbonit fiber-cement flat panels

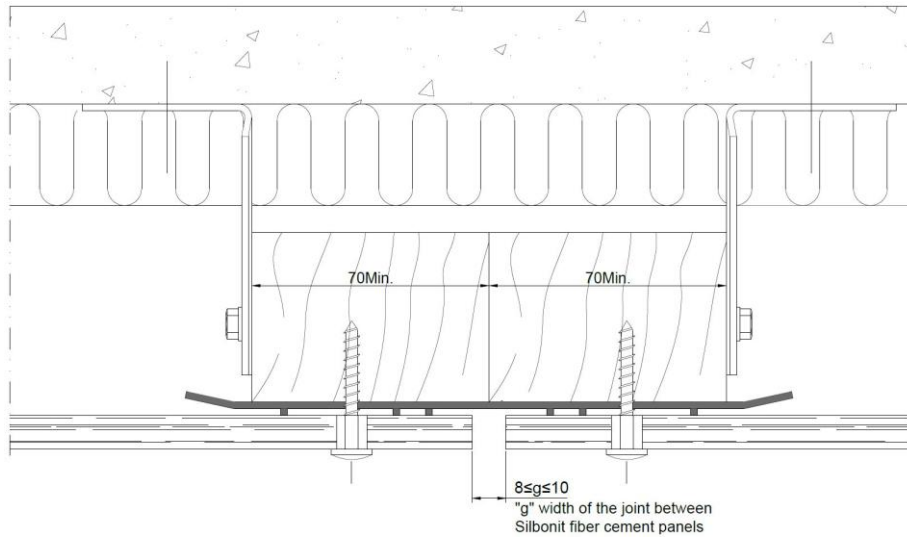

Image 25 – Example of a horizontal section of the ventilated facade package along a vertical joint between panels. Note the protective gasket and the minimum width of the wooden battens.

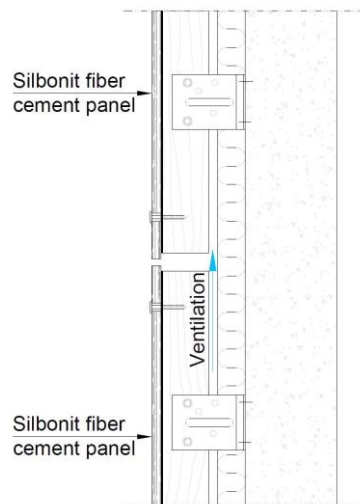

Image 26 – Example of a vertical section of the ventilated facade package along a horizontal joint between panels. Wooden subframe and Silbonit fiber-cement flat-panel cladding.

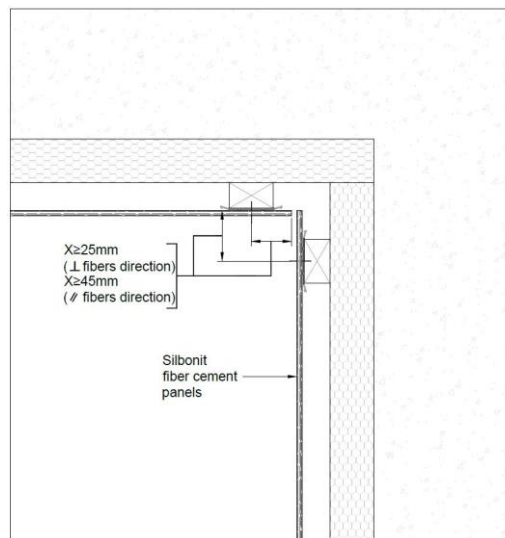

Image 27 – Example of a horizontal section of the ventilated facade package along an inner corner with an open vertical joint between the cladding panels. Wooden subframe.

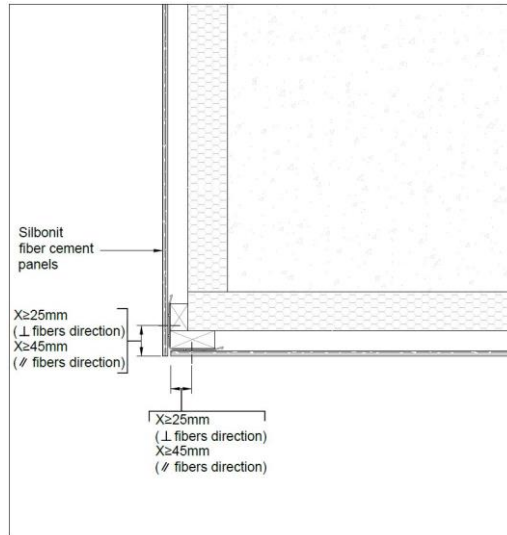

Image 28 – Example of a horizontal section of the ventilated facade package along an external corner with an open vertical joint between the cladding panels. Wooden subframe.

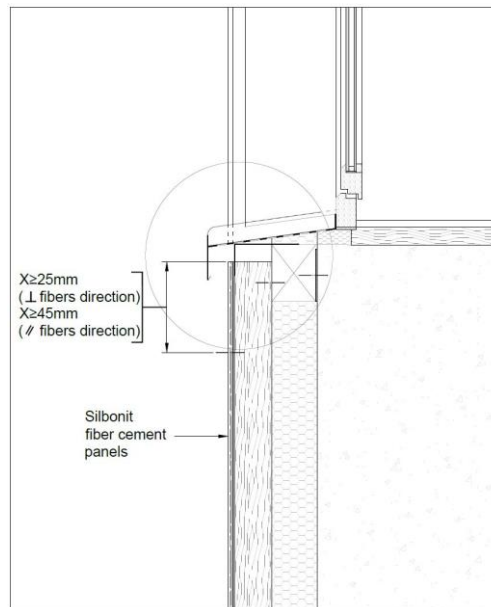

Image 29 – Example of vertical section of a ventilated facade along a window. Wooden subframe.

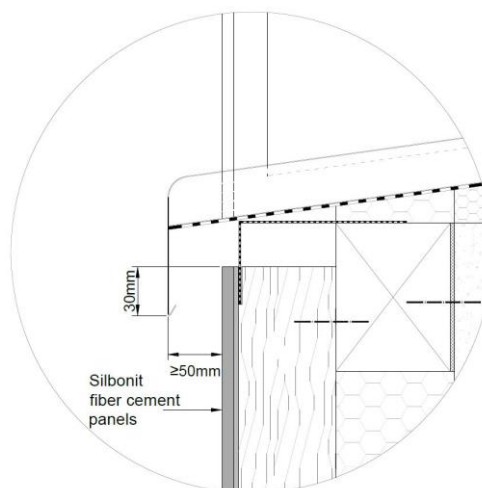

Image 30 – Example of vertical section of a detail of the cladding beneath a window.

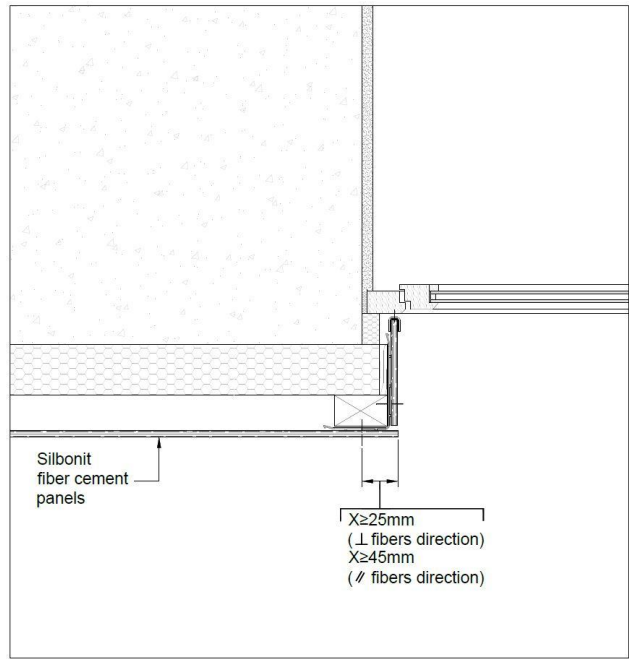

Image 31 – Example of horizontal section of a ventilated facade along a window. Wooden subframe.

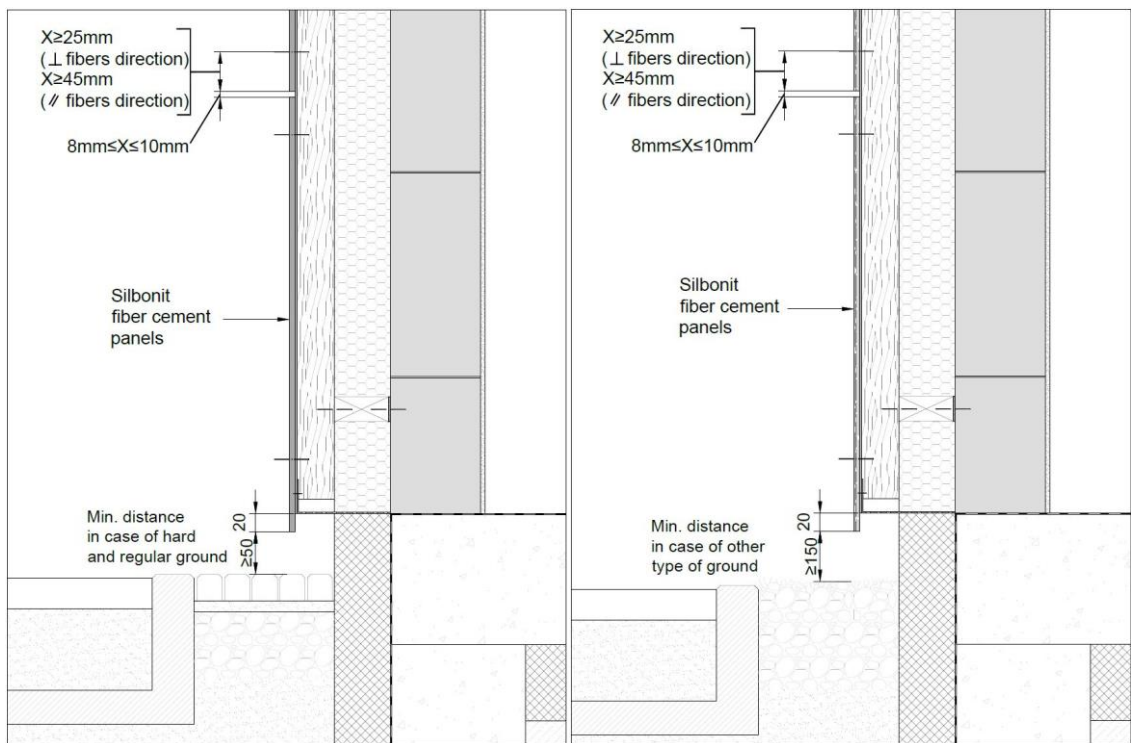

Image 32 – Example of vertical sections of the base of the ventilated facade cladding with two different slab solutions at the base of the building. Wooden subframe.

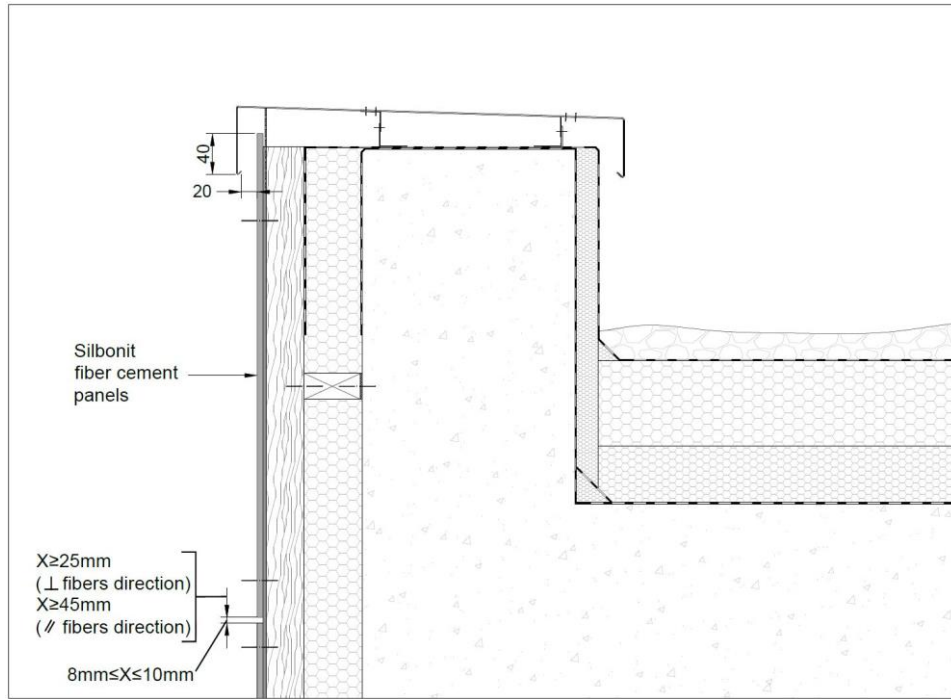

Image 33 – Example of vertical sections of the coping of the ventilated facade cladding. Wooden subframe.

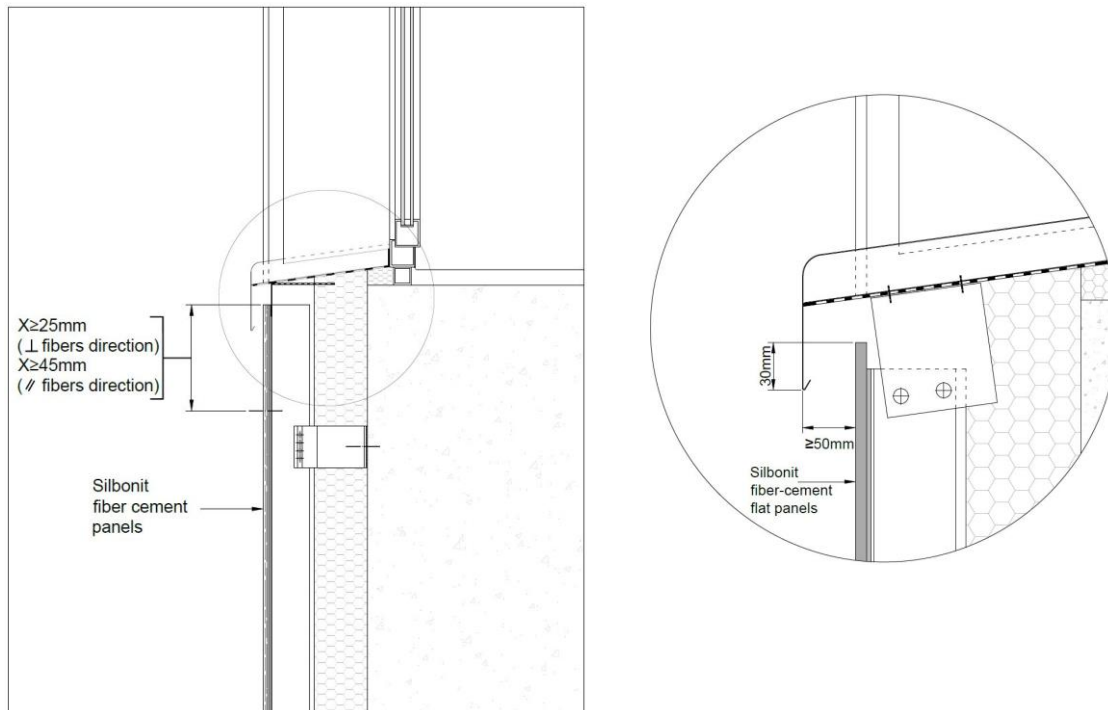

Image 34 – Example of vertical section of a ventilated facade along a window. Aluminum subframe.

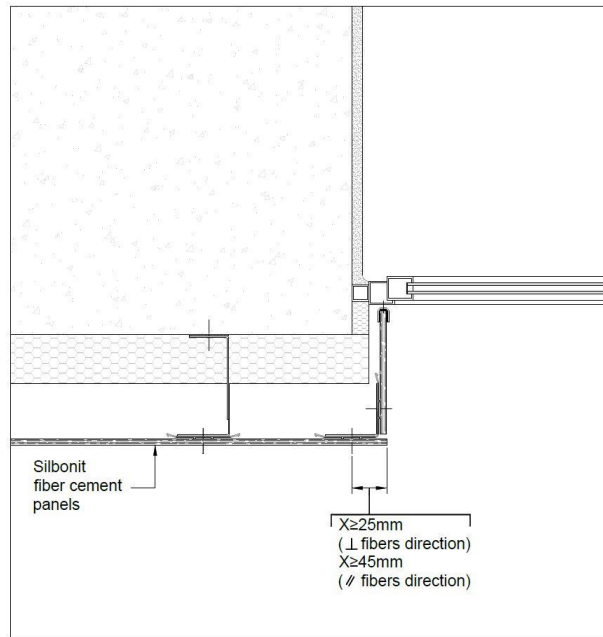

Image 35 – Example of horizontal section of a ventilated facade along a window. Aluminum subframe.

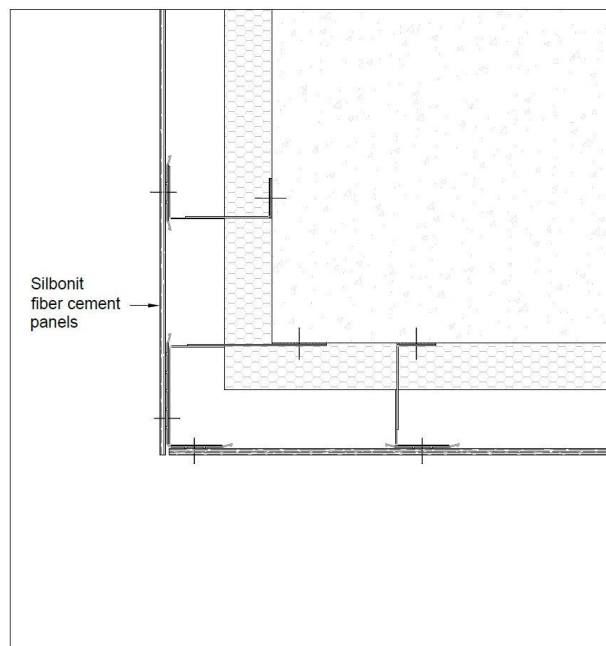

Image 36 – Example of a horizontal section of the ventilated facade package along an external corner with an open vertical joint between the cladding panels. Aluminum subframe.

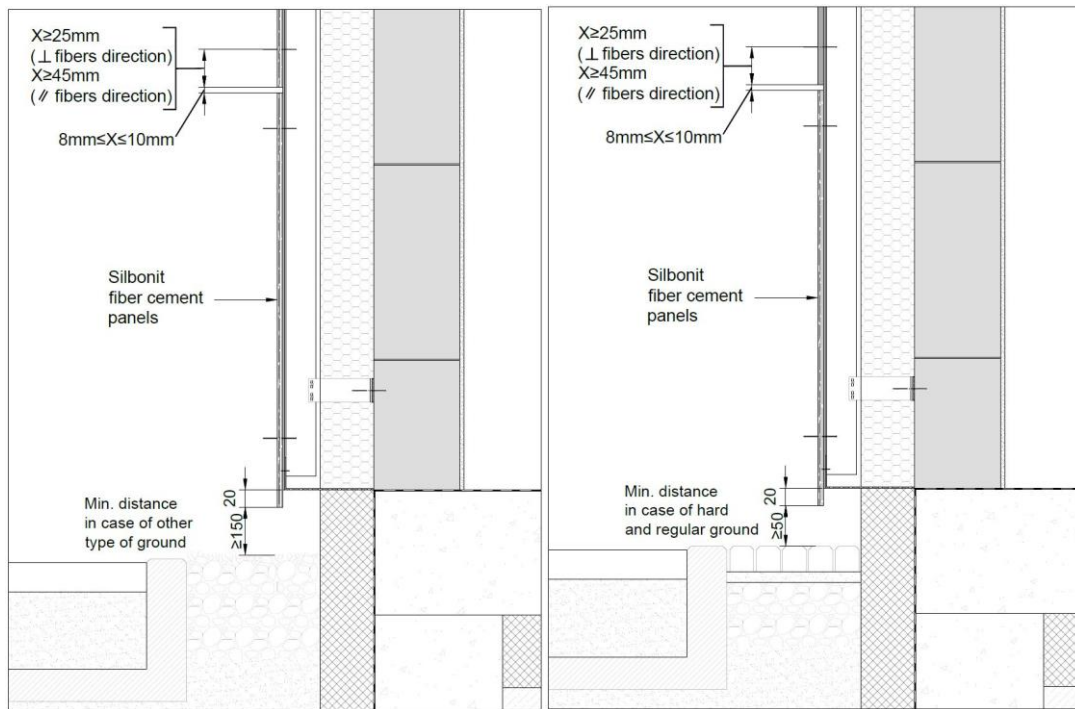

Image 37 – Example of vertical sections of the base of the ventilated facade cladding with two different slab solutions at the base of the building. Aluminum subframe.

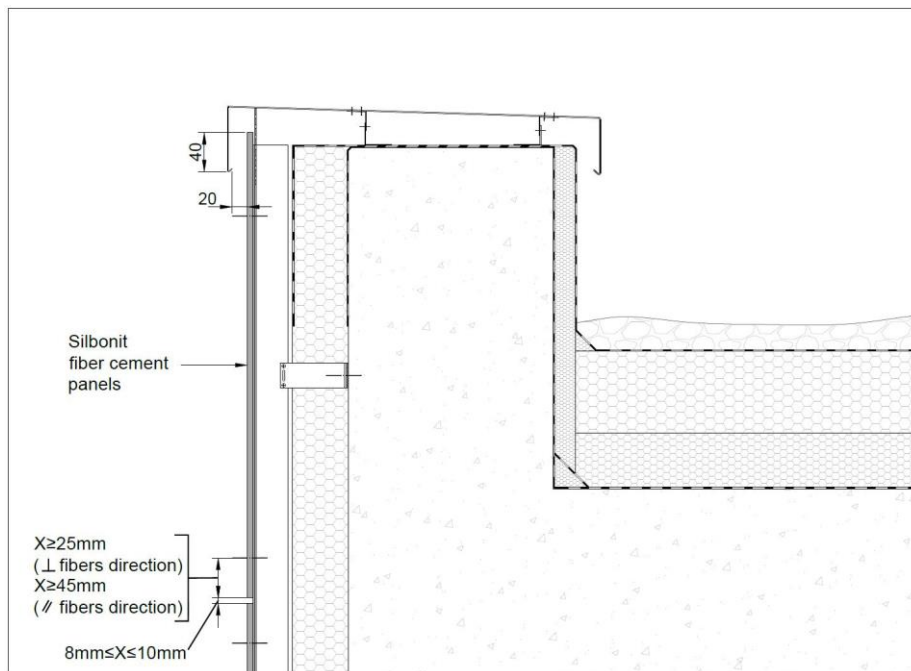

Image 38- Example of a vertical section of the coping of the ventilated facade cladding. Aluminum subframe.

7.2 Transport, handling, and storage of Silbonit fiber-cement panels

7.2.1 Transport and handling of panels

Panel packages must only be transported by covered vehicles. Unloading must be carried out with suitable machinery and tools. During handling, the belts, spacers, and forks of any forklift trucks must be suitably equipped to ensure weight is evenly distributed and package deformation is restricted to a minimum.

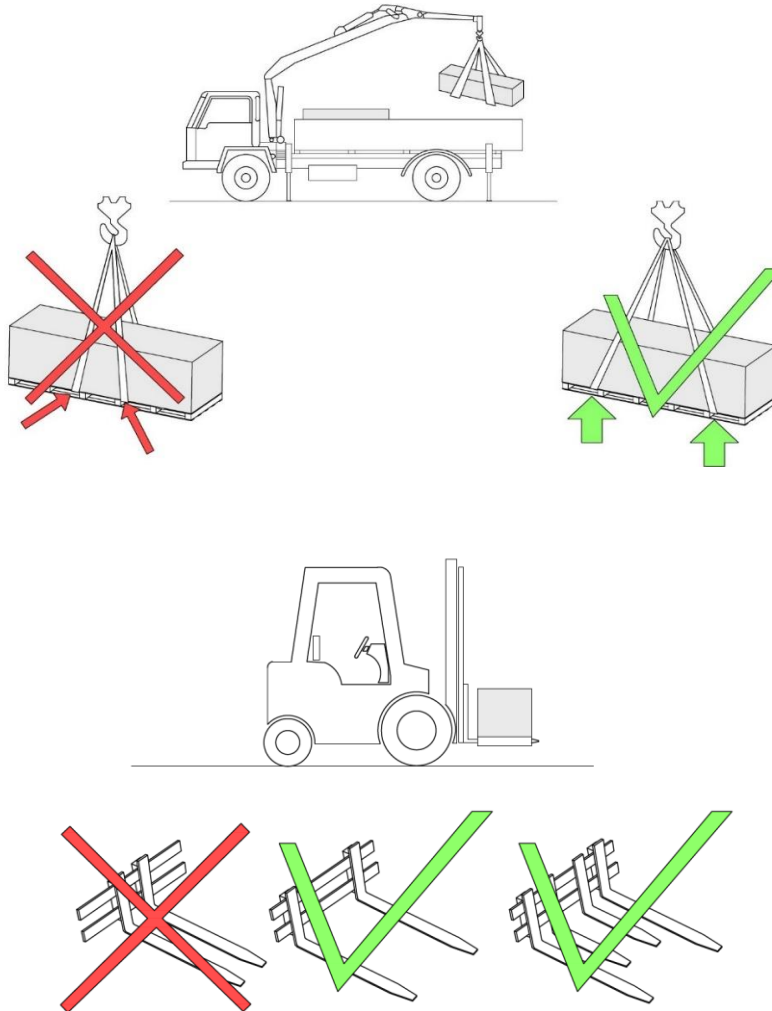

Image 39– Transport and handling of panels

Only one package should be transported at a time.

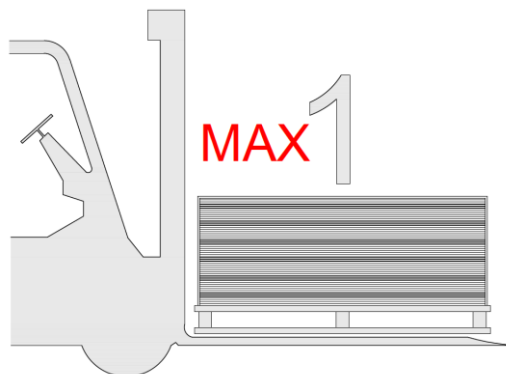

Image 40 – The packages must be handled individually

7.2.2 Storage of panels

The panel packages must be stored in well-ventilated, indoor, and dry rooms, protected from atmospheric agents and sunlight. The panels must be stored with their own pallet, which must lie on a flat, dry surface. For prolonged storage, at least a part of the protective plastic should be removed from the packages. The panels must never come into direct contact with the ground. During this storage phase, condensation, rain, or stagnant water may permanently damage the panels.

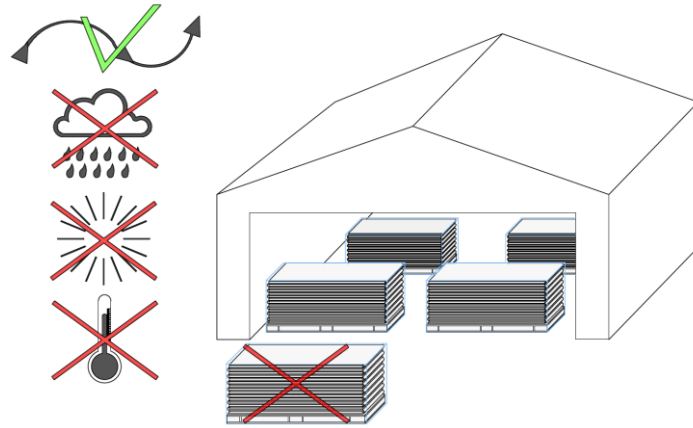

Image 41– Storage of panels

7.2.3 Manual handling of panels

The panels must be handled carefully so as not to damage their surface, corners, and edges, taking care to protect them from dirt and moisture.

The panels must be lifted from their package without being dragged against the panels below. Each panel must be handled by two people, one on each side. The panels must never be propped vertically, not even temporarily.

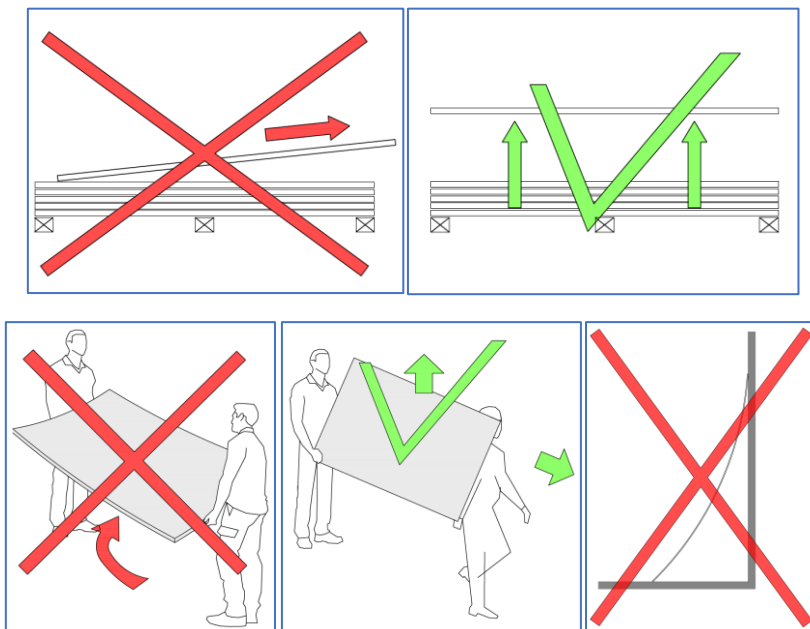

Image 42 – Manual handling of panels

No more than 2 standard-sized products may be stacked on top of each other. Packages of different sizes must not be stacked on top of each other.

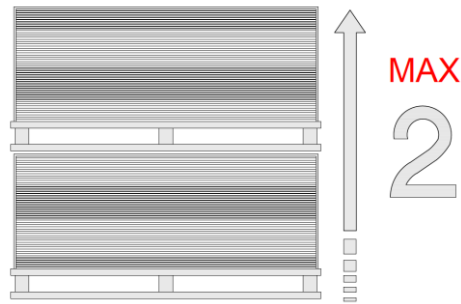

Image 43 – Package stacking

7.3 Preparing panels for assembly – work on site

7.3.1 General information

Sometimes work and operations need to be carried out on individual panels before installation, such as drilling and cuts for resizing. The following instructions allow this to be completed correctly.

- All work on the panels, such as resizing and drilling, must be carried out on the panels before assembly
- The work surface that the cuts or holes are made on must be flat, continuous, and clean, so that the panel is not subjected to tension due to incorrect positioning
- The panels must be placed on the worktop with care and must be worked on individually with suitable equipment, taking care not to damage the surface or edges
- When Silbonit fiber-cement panels are mechanically processed (cutting, drilling), dust is released that can be harmful to health. For this reason, appropriate precautions must be taken before carrying out all work, using suitable equipment and wearing suitable protection (PPE). These mechanical operations must be carried out in suitably ventilated rooms
- All work must be carried out dry, without tools using water or other liquids
- The tools used must be equipped with an adequate suction system
- Adhesive tape and/or labels must not be applied on the visible surface, nor any writing or engraving, as this would irreparably damage the panel
- Before proceeding with the work, consult the product safety data sheets available at <https://www.sil-lastre.com/download-2/>

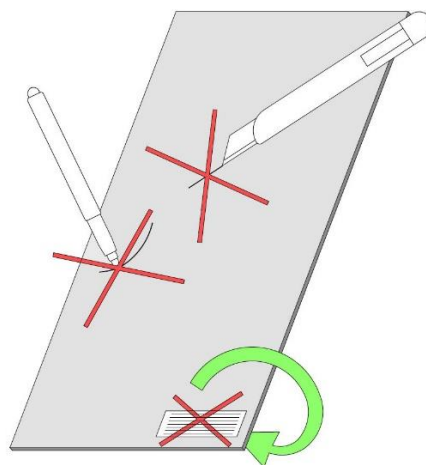

Image 44 – Particular care must be taken not to damage the visible surface of the panels during work on site

7.3.2 Cutting

Below are some specific instructions for cutting on site.

When panels arrive from the production plant, whether in standard or resized dimensions, they have treated surfaces and edges (unless otherwise specified by the manufacturer). To cut panels at the production plant, blades with the following specifications are generally used:

- Diameter: 400 mm
- Diamond cutting edge thickness: 3.2 mm
- Rotation speed: 2000-2500 rpm
- Feed speed: 3 m/minute

These blades leave a clean edge with a good quality finish.

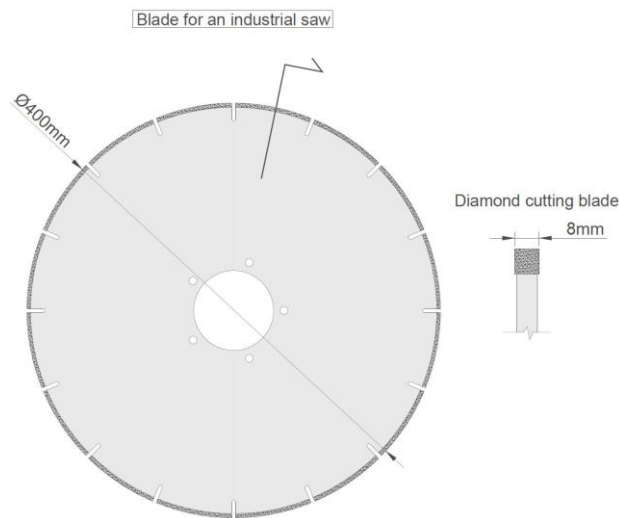

Image 45 – Example of a blade used to cut the panels at the Società Italiana Lastre SpA plant

When performing the cut, the blade must slice the panel starting from the visible surface.

After cutting, the edge must be sanded, and the dust immediately aspirated. If required, cleaning must be completed with low-pressure air or using a clean microfiber cloth, without rubbing.

After cutting on site, the sectioned edge must be treated as described in section 7.3.4, “Operations to carry out on the panels after each machining”. Panels with Hydro, Hydroplus, and Spectra finishing do not require the edges to be treated (except for aesthetic purposes in the case of Spectra panels).

On request, the panels can be supplied cut to size. In this case, the customer is required to provide Società Italiana Lastre with a precise cutting diagram.

7.3.3 Holes

The panels must be drilled before being fitted to the subframe. Below are some specific instructions for making further holes on site in addition to the ones made at the production plant.

- The holes must not be made using hole-punching tools
- The panels must be perforated starting from the visible side of the panel and drilling through
- For treated panels (excluding Hydro, Hydroplus, and Spectra panels), whether the holes are made at the production plant or on site, they must receive a protective treatment as explained in section 7.3.4 “Operations to carry out on the panels after each additional machining”
- When drilling the holes, follow the distances indicated in sections 6.3.3.1 - 6.3.4 - 6.3.5 - Tables 12 and 14
- After the holes have been drilled, the dust must be immediately aspirated. If required, cleaning can be completed using a clean microfiber cloth without rubbing. Each hole should be treated as indicated in section 7.3.4,

“Operations to be carried out on certain types of finishing”, after any mechanical machining. Panels with Hydro, Hydroplus, and Spectra finishing do not need to be treated

Upon request the panels can be supplied pre-drilled. In this case, the customer is required to provide Società Italiana Lastre with a precise drilling diagram. At the plant, Società Italiana Lastre can only drill through-holes.

7.3.4 Operations to carry out on the panels after each additional machining

After making cuts and/or holes, the cut edges and surfaces must be cleaned and, for certain types of product, protective treatment must also be applied (see points 7.3.2 and 7.3.3).

7.3.4.1 Cleaning the panels after cutting and/or drilling

Immediately after machining and before installing the panels, any cutting and drilling residues or dust must be removed. If they remain on the surface, they could irreparably damage the panel.

The cleaning procedure is as follows:

- remove any dust from the surface of the panel, even using a standard vacuum cleaner
- if dust persists, blow with low-pressure air, or use a clean microfiber cloth without rubbing

7.3.4.2 Protective treatment of cut surfaces

For some finishes, a protective treatment must be applied after cuts have been made on site.

At the customer's request, SIL can supply specific products which are suitable for the protective or aesthetic treatment of cut edges.

7.3.4.3 Protective treatment of drilled surfaces

Moisture stains may appear around the holes over time. For Crystal and Pigmenta finishes, the sides of the holes must be treated with a special acrylic product supplied on request, whether they were drilled at the plant or on site.

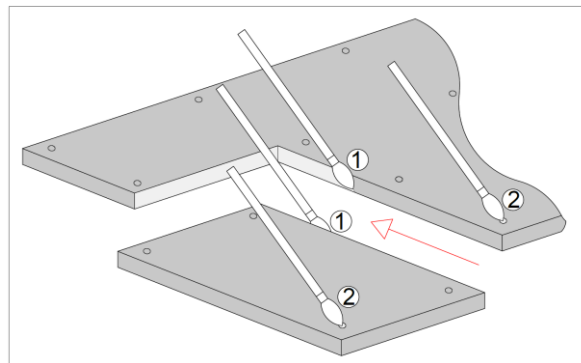

Image 46 – Treatment to be carried out on site before the panels are installed, if made necessary by additional cuts and holes. For certain types of panels, the treatment is also required on holes made at the plant.

7.4 Assembling and installing the fiber-cement cladding

During installation, the panels must be secured starting from the fixed point and moving towards the sliding points located at the periphery.

Where possible, the fixed point must be positioned at the central part of the panel (see section 6.5.2.1). To complete the sliding points correctly, the screws should not be overly tightened, allowing the panels to expand freely. Suitable tools, such as torque-controlled screwdrivers and stroke limiter, must be used during installation. Guidance systems for drilling holes and using self-drilling fastenings are also available. These systems make it possible to correctly center the axis of the hole and guide the fastening perpendicularly to the panel.

When creating lighting points, lighting system cavities, or other types of holes requiring the use of glues, silicones, or sealants, care must be taken not to mark the wall with such products, which would result in irreparable damage.

7.5 Accessory operations and maintenance of ventilated facades made with Silbonit panels

After installation, if necessary, the facade can be washed using a low-pressure water jet. The surface of the panels must not be rubbed in any way.

For panels treated with acrylic paint (Crystal and Pigmenta), any graffiti on the panel can be removed using solvent.

The panels must not be cleaned during the hours when the facade is exposed to the sun or while the surface is still warm.

An annual inspection is recommended to check that the panels are in good condition and that the fastenings are holding properly.

Although care has been taken to prepare this information, it is not binding. SIL reserves the right to modify the details at any time. For up-to-date information on the technical data and product finishes, please refer to the following website: <https://www.sil-lastre.com/download-2/>



**SOCIETÀ
ITALIANA
LASTRE** S.p.A.

Via F.Lenzi, 26 - 25028 - Verolanuova - BS

Tel: 030 9920900

Email: info@sil-lastre.com

Web: <https://www.sil-lastre.com>